

FerroTec

Genius II User Manual



Revision History, 0101-9032-0

| Rev. | Description | Application/Reason for Change | Date | Approved By |
|------|--|---|------------|-------------|
| — | Preliminary version of manual, provided for on-site training. | Covers Genius II configuration and operation in stand-alone mode (i.e., with all control modules configured as Local). | Sept. 2014 | IA |
| A | First released version of manual. | Section 1-7 cover Genius II installation, configuration, and operation in all operational modes. Sections 8 and 9 cover Troubleshooting and Maintenance, respectively. | Dec. 2014 | IA |
| B | Updated screens in all sections as necessary. Expanded section 3.4.2. Inserted new sections 3.6, 3.7, and 3.9. Reorganized section 5.6, adding new numbered subheadings. Revised Sections 6, 7, and 8 extensively. Made minor revisions to Appendix A and created new Appendix B. Copy-edited and updated text and updated screen illustrations throughout the manual. | Manual now applies to Revision 1.2.1 of the Genius II software and the following revisions of firmware for specific control modules: HVPS: 1.3.3; FPS: 1.5.3; Sweep: 2.0.206; Turret: 1.5.42. | March 2018 | IA |
| C | Minor revisions to Tables 6-1, 6-2, and 6-3. | Corrections supplied by Temescal Automation Engineering | March 2018 | IA |
| D | Revised Figure 2-5 and added new Figures 2-6 and 2-7. Revised final paragraph on p. 2-6, which explains Figures 2-5 through 2-7. | Per Engineering input, clarified and expanded illustrations for interlock methods and requirements regarding the PC door interlock. | Oct. 2018 | IA |

Table of Contents

| <u>Section Number and Title</u> | <u>Page Number</u> |
|---|--------------------|
| 1 Introduction to the Genius II Controller | 1-1 |
| 1.1 Section Overview | 1-1 |
| 1.2 Product Description..... | 1-1 |
| 1.3 The Main User Interface Screen | 1-3 |
| 1.4 Control/Display Features of Remote Controller | 1-4 |
| 1.5 Genius II Operating Modes | 1-7 |
| 1.6 Main Controller Screens Accessible in Multiple Modes | 1-11 |
| 2 Installation | 2-1 |
| 2.1 Section Overview | 2-1 |
| 2.2 Basic Hardware Installation..... | 2-2 |
| 2.3 Making Cable Connections in to Components Controlled by the Genius II | 2-2 |
| 2.4 Making Connections to Higher Level Controllers..... | 2-6 |
| 2.5 Connecting the AC Power Cable and Powering Up the Genius II..... | 2-10 |
| 3 Basic Configuration Procedures..... | 3-1 |
| 3.1 Section Overview | 3-1 |
| 3.2 Putting the Genius II into Configuration Mode | 3-1 |
| 3.3 Making Selections on the Configuration>Main Screen | 3-2 |
| 3.4 Configuring the E-Beam and Filament Power Supplies | 3-3 |
| 3.5 Configuring the Turret Control Module..... | 3-5 |
| 3.6 Configuring the Sweep Control Module | 3-7 |
| 3.7 Enabling the LogIn Manager and Assigning User Passwords (Optional) | 3-13 |
| 3.8 Optional Assignment of Material Names to Pockets | 3-14 |
| 3.9 Exiting Configuration Mode and Saving Configuration Changes | 3-15 |
| 4 Operational Overview | 4-1 |
| 4.1 Section Overview | 4-1 |
| 4.2 Powering Up the Genius II..... | 4-1 |
| 4.3 Logging In and Logging Off | 4-2 |
| 4.4 Navigating Between Operating Modes..... | 4-4 |
| 4.5 Responding to Alarms | 4-5 |
| 4.6 The Main Controller's Touch Screen..... | 4-6 |
| 4.7 General Operating Methods | 4-8 |
| 4.8 Changes in Main UI Screens Depending on Configuration | 4-13 |

| | | |
|----------|--|------------|
| 5 | Stand Alone Operation of the Genius II | 5-1 |
| 5.1 | Section Overview | 5-1 |
| 5.2 | Installation and Configuration | 5-1 |
| 5.3 | Use of the Function Control Buttons on the Main UI's Main Button Bar | 5-2 |
| 5.4 | Display Features of the Operations>Main Screen | 5-2 |
| 5.5 | Operating and Monitoring the E-Beam Power Supply | 5-2 |
| 5.6 | Creating and Modifying Sweep Programs from the Ops>Sweep Screen | 5-5 |
| 5.7 | Genius II Operation from the Hand-Held Remote Controller | 5-18 |
| 6 | Genius II Operation with a Deposition Controller | 6-1 |
| 6.1 | Section Overview | 6-1 |
| 6.2 | Genius II Operation with a Single-Layer Deposition Controller | 6-1 |
| 6.3 | Genius II Operation with a MultiLayer Deposition Controller | 6-3 |
| 7 | Genius II Operation With a PLC-Based System Controller | 7-1 |
| 7.1 | Section Overview | 7-1 |
| 7.2 | Operation with All Control Modules Configured as <i>Remote I/O</i> | 7-1 |
| 7.3 | Genius II Operation with the EtherCAT Option Implemented | 7-3 |
| 8 | Troubleshooting | 8-1 |
| 8.1 | Section Overview | 8-1 |
| 8.2 | The Diagnostics Screen | 8-1 |
| 8.3 | Genius II Service Mode Screens | 8-4 |
| 8.4 | Alarm Messages | 8-6 |
| 9 | Maintenance Procedures | 9-1 |
| 9.1 | Section Overview | 9-1 |
| 9.2 | Replacing a Control Module | 9-1 |
| 9.3 | Replacing the Hard Drive | 9-5 |
| | Appendix A: Gateway Selection and Memory Mapping for EtherCAT Implementaton | A-1 |
| | Appendix B: RS-232 Communications Protocols | B-1 |

List of Illustrations

| Figure Number and Title | Page Number |
|---|--------------------|
| Figure 1-1 Genius II Front Panel..... | 1-2 |
| Figure 1-2 Control/Display Features of Hand Held Remote Controller | 1-3 |
| Figure 1-3 Functionally Distinct Areas of Main UI Screen..... | 1-3 |
| Figure 1-4 Operations>Main Screen with Auxiliary Menu Displayed..... | 1-4 |
| Figure 1-5 Remote Controller Screens Available in Configuration Mode | 1-4 |
| Figure 1-6 Remote Ctr. Screens in Ops Mode, All Control Modules Configured as Local | 1-5 |
| Figure 1-7 Configuration Mode Screens (All Control Modules Configured as Local) | 1-6 |
| Figure 1-8 Operations Mode Screens when all Control Modules Are Configured as Local | 1-8 |
| Figure 1-9 Operations Mode Screens When All Control Modules Are Configured as EtherCAT | 1-9 |
| Figure 1-10 Operations Mode Screens When All Control Modules Are Configured as RS-232 | 1-10 |
| Figure 1-11 Manual Mode Screens..... | 1-11 |
| Figure 1-12 Service Mode Screens..... | 1-12 |
| Figure 1-13 The Alarms Screen | 1-13 |
| Figure 1-14 The Diagnostics Screen, All Control Modules Configured as Local..... | 1-13 |
| Figure 1-15 The Diagnostics Screen, All Control Modules Configured as Remote I/O | 1-13 |
| Figure 1-16 The Language Selection/Software Version ID Screen..... | 1-14 |
| Figure 2-1 Genius II Front Panel, Showing Connections Port for Hand Held Remote Controller | 2-1 |
| Figure 2-2 Genius II Rear Panel Connectors | 2-2 |
| Figure 2-3 Genius II Cabling Diagram | 0-4 |
| Figure 2-4 Required Interlock Connections to Rear Panel X110..... | 2-6 |
| Figure 2-5 Connector X015 Connected to a Product Chamber Door Interlock Switch Energized by 24 VDC Power Supplied by the Genius II | 2-7 |
| Figure 2-6 Connector X105 Connected to a Product Chamber Door Interlock Switch Energized by an External 24 VDC Power Supply | 2-7 |
| Figure 2-7 Connector X105 Jumpered as Required When Not Connected to a Product Chamber Door Interlock Switch | 2-7 |
| Figure 2-8 Connections to Rear Panel Connector X110, Genius II Connected to Deposition Controller ... | 2-8 |
| Figure 2-9 Sample Circuit Supplying BEAM ON and BEAM OFF Inputs via X110 Pins 5 and 6 | 2-9 |
| Figure 2-10 Connections to Rear Panel Connector X119, Configuration #1 | 2-10 |
| Figure 2-11 Connections to Rear Panel Connector X119, Configuration #2 | 2-10 |
| Figure 2-12 Genius II Input Power Cable Receptacle and Rear Panel On/Off Switch..... | 2-11 |
| Figure 3-1 Genius II Boot-Up Screen | 3-1 |
| Figure 3-2 Config>Main Screen After Initial Boot-Up | 3-2 |
| Figure 3-3 Configuration>Main Screen with All Control Modules Configured as Local | 3-2 |
| Figure 3-4 Displaying the System Date/Time Screen | 3-3 |
| Figure 3-5 System Date/Time Screen | 3-3 |
| Figure 3-6 System Date/Time Screen with Date-Entry Popup Displayed | 3-4 |
| Figure 3-7 System Date/Time Screen with Time-Entry Popup Displayed | 3-4 |
| Figure 3-8 The Configuration E-Beam Screen at Initial Boot-Up | 3-5 |
| Figure 3-9 The Emission Tuning Page at Initial Boot-Up..... | 3-6 |
| Figure 3-10 Emission Tuning Page with Entry Boxes for Break Point Outlined | 3-6 |
| Figure 3-11 Emission Tuning Page with Value Display Boxes and Adjustment Buttons for Proportional Term Outlined | 3-7 |
| Figure 3-12 Emission Tuning Page with Value Display Boxes and Adjustment Buttons for Integral Term Outlined | 3-8 |
| Figure 3-13 The Emission Graph Page When Emission Current Tracing Is Inactive..... | 3-8 |
| Figure 3-14 The Emission Graph Page When Emission Current Tracing Is Active..... | 3-9 |
| Figure 3-15 Config>Turret Screen at Initial Boot-Up | 3-10 |
| Figure 3-16 Config>Turret Screen when Number of Pockets is 1..... | 3-11 |
| Figure 3-17 Config>Turret Screen Displaying Keypad for Entry of Continuous Rotation Speed | 3-11 |
| Figure 3-18 Config>Turret Screen After User Enters 15% for Continuous Rotation Speed..... | 3-12 |
| Figure 3-19 Config>Turret Screen when Turret Control Module Is Configured as <i>Remote I/O</i> | 3-12 |

| | | |
|-------------|--|------|
| Figure 3-20 | Config>Sweep Screen in its Initial State | 3-13 |
| Figure 3-21 | Config>Sweep Screen After User Selects Disabled for Operate Modify..... | 3-13 |
| Figure 3-22 | Change in Size of Bounding Box Depending on the <i>Drive Range</i> Value | 3-14 |
| Figure 3-23 | Buffer Zone Defined by the Drive Limit Value..... | 3-15 |
| Figure 3-24 | 'Clipping' of Beam Sweep Pattern Depending on the <i>Drive Limit</i> Value | 3-15 |
| Figure 3-25 | Profiles Pages 1 and 2 | 3-16 |
| Figure 3-26 | Profiles Page 2 at Initial Boot-Up | 3-17 |
| Figure 3-27 | Profiles Page 2 After Pocket-Profile Assignments Are Changed..... | 3-17 |
| Figure 3-28 | Keyboard After User Enters <i>T/</i> | 3-18 |
| Figure 3-29 | Profiles Page 2 After User Enters <i>T/</i> for Pocket 1 | 3-18 |
| Figure 3-30 | Profiles Page 1, in its Initial State | 3-19 |
| Figure 3-31 | Profiles Page 1 In Editing Mode A | 3-19 |
| Figure 3-32 | Profiles Page 1 In Editing Mode B | 3-19 |
| Figure 3-33 | Features Displayed on Profiles Page 1 when in Editing Mode B | 3-20 |
| Figure 3-34 | Profiles Page 1 in Editing Mode B, Beam Switched On | 3-22 |
| Figure 3-35 | Remote Controller in Config Mode, Beam On at 5%, Menu 2 Displayed | 3-23 |
| Figure 3-36 | Beam at Correct Position for Negative Latitudinal Limit | 3-24 |
| Figure 3-37 | Remote Controller Screen After User Sets the -Lat Beam Position Interlock Limit | 3-24 |
| Figure 3-38 | Beam at Correct Position for Positive Latitudinal Limit | 3-25 |
| Figure 3-39 | Remote Controller Screen After User Sets +Lat Beam Position Interlock Limit | 3-25 |
| Figure 3-40 | Beam at Correct Position for Negative Longitudinal Beam Limit | 3-26 |
| Figure 3-41 | Remote Controller Screen After User Sets -Long Beam Position Interlock Limit..... | 3-26 |
| Figure 3-42 | Beam at Correct Position for Positive Longitudinal Beam Limit | 3-27 |
| Figure 3-43 | Remote Controller Screen After User Sets +Long Beam Position Interlock Limit | 3-27 |
| Figure 3-44 | Profiles Page 1 After All Four Beam Position Interlock Limits Are Reset..... | 3-28 |
| Figure 3-45 | Profiles Page 1 After User Accepts the New Beam Position Interlock Limits..... | 3-28 |
| Figure 3-46 | Operations>Sweep Screen After Beam Position Limits Are Set..... | 3-29 |
| Figure 3-47 | The Config>Main Screen..... | 3-29 |
| Figure 3-48 | The LogIn Manager Screen When Initially Displayed..... | 3-30 |
| Figure 3-49 | LogIn Manager Screen After LogIn Manager Is Enabled..... | 3-30 |
| Figure 3-50 | Configuration Mode Screen with Alternative Menu Displayed | 3-31 |
| Figure 3-51 | Diagnostics Screen | 3-31 |
| Figure 3-52 | Language Selection/Software Version Screen | 3-32 |
| Figure 3-53 | LogIn Manger Screen with Alternative Menu Displayed | 3-32 |
| Figure 3-54 | User Exiting Configuration Mode, Mode Select Popup Displayed..... | 3-33 |
| Figure 4-1 | Genius II Boot-Up Screen when Initially Displayed | 4-2 |
| Figure 4-2 | Genius II LogIn Screen..... | 4-2 |
| Figure 4-3 | Splash Screen with LogIn Popup Displayed..... | 4-3 |
| Figure 4-4 | Operations>Main Screen with Standard Menu Displayed..... | 4-3 |
| Figure 4-5 | Operations>Main Screen with Auxiliary Menu Displayed..... | 4-4 |
| Figure 4-6 | Log-Off Popup | 4-4 |
| Figure 4-7 | Local>Main Screen with Change Mode Popup Displayed | 4-5 |
| Figure 4-8 | Main User Interface Displaying an Alarm Message..... | 4-5 |
| Figure 4-9 | Alarm Details Screen with Active Alarms, <i>Exclude History</i> Selected..... | 4-6 |
| Figure 4-10 | Alarm Details Screen with Active Alarms, <i>Exclude History</i> Selected..... | 4-6 |
| Figure 4-11 | Functional Areas of Genius II User Interface as It Appears in Configuration, Operations, and Manual Modes | 4-7 |
| Figure 4-12 | Local>Main Screen with Auxiliary Menu Displayed..... | 4-8 |
| Figure 4-13 | Command Button Bar After User Presses the CHANGE Button..... | 4-9 |
| Figure 4-14 | Numeric Keypad for Entering a Beam Power Percentage Setpoint | 4-9 |
| Figure 4-15 | User Has Entered 5% Power Setpoint via Numeric Keypad..... | 4-10 |
| Figure 4-16 | E-Beam Button After User Sets 5% as Beam Power Setpoint..... | 4-10 |
| Figure 4-17 | Pocket Button When Turret Is Rotating | 4-11 |
| Figure 4-18 | Operations>E-Beam Screen when Gun is ON and HV is OFF..... | 4-13 |
| Figure 4-19 | Changes to Ops>Main Screen When Sweep Module Is Configured as Offline | 4-14 |
| Figure 4-20 | Changes to Diagnostics Screen When Sweep Module Is Configured as Offline..... | 4-14 |
| Figure 4-21 | Changes to Ops>Sweep Screen When Sweep Module Is Configured as Remote I/O | 4-15 |
| Figure 5-1 | Operations>Main Screen..... | 5-2 |
| Figure 5-2 | Operations>E-Beam Screen, Beam On at 0.0 mA..... | 5-3 |

| | | |
|-------------|---|------|
| Figure 5-3 | Operations E-Beam Screen with Numeric Keypad Displayed | 5-3 |
| Figure 5-4 | Operations>E-Beam Screen, Beam on at 5% Power | 5-4 |
| Figure 5-5 | Operations>E-Beam Screen when HV and Gun Are Both Switched Off | 5-4 |
| Figure 5-6 | Operations>E-Beam Screen when Gun is ON and HV is OFF | 5-5 |
| Figure 5-7 | Operations>Sweep Screen in Editing Mode, Beam Off, Sweep On..... | 5-6 |
| Figure 5-8 | Ops>Sweep Screen, Not in Edit Mode, Sweep On, Beam Off..... | 5-6 |
| Figure 5-9 | Ops>Sweep Screen, Beam and Sweep On..... | 5-8 |
| Figure 5-10 | Ops>Sweep Screen After User Touches the Longitude Frequency Button to Change the Value of that Sweep Parameter..... | 5-8 |
| Figure 5-11 | Ops>Sweep Screen, User Has Entered 2 as New Longitude Frequency Value..... | 5-8 |
| Figure 5-12 | Ops>Sweep Screen After User Changes Longitude Frequency to 2..... | 5-9 |
| Figure 5-13 | User Saving Change Made to Currently Operational Program..... | 5-9 |
| Figure 5-14 | Ops>Sweep Screen After User Saves Changes Made to Currently Displayed Program and Exits from Sweep-Edit Mode | 5-10 |
| Figure 5-15 | Ops>Sweep Screen with <i>Load Location</i> Popup Displayed and Currently Displayed Sweep Program Selected..... | 5-11 |
| Figure 5-16 | Load Location Popup with Pocket 3, Program 2 Entered..... | 5-11 |
| Figure 5-17 | Local Sweep Screen After Pocket 3, Program 2 Loaded For Background Editing | 5-12 |
| Figure 5-18 | The Program 3, Pocket 2 Sweep Pattern After User Makes Parameter Changes..... | 5-12 |
| Figure 5-19 | <i>Save Target</i> Popup Displaying the Procedure's Original Pocket and Program..... | 5-13 |
| Figure 5-20 | <i>Save Target</i> Popup After User Enters 3 for Pocket and 2 for Program..... | 5-13 |
| Figure 5-21 | Ops>Sweep Screen with Sine Waveform Sweep Pattern Selected..... | 5-15 |
| Figure 5-22 | Ops>Sweep Screen After Arbitrary Waveform Is Selected..... | 5-15 |
| Figure 5-23 | <i>Select File</i> Dialog Box for Arbitrary Waveforms When Initially Displayed..... | 5-16 |
| Figure 5-24 | <i>Select File</i> Dialog Box, User Has Selected <i>Spiral01.txt</i> | 5-16 |
| Figure 5-25 | Ops>Sweep Screen, in Edit Mode, Displaying Spiral01 Arbitrary Waveform..... | 5-16 |
| Figure 5-26 | <i>Save Target</i> Popup Displaying Pocket and Program Numbers of Program Displayed at Beginning of Procedure..... | 5-17 |
| Figure 5-27 | Spiral01 Arbitrary Waveform Saved as Program 1 of Pocket 2 | 5-17 |
| Figure 5-28 | Remote Controller Screen in Ops Mode, Menu 1 Selected, Beam and Sweep Off | 5-19 |
| Figure 5-29 | Remote Controller Screen in Ops Mode, Menu 2 Selected, Beam and Sweep On | 5-20 |
| Figure 6-1 | Operations E-Beam Screen when <i>External</i> Is Selected for <i>Emis Control</i> | 6-2 |
| Figure 6-2 | Appearance of Operations Mode Screens when All Control Modules Are Configured as <i>Remote I/O</i> | 6-4 |
| Figure 7-1 | Genius II Boot-Up Screen | 7-2 |
| Figure 7-2 | Config>Main Screen After Initial Boot-Up | 7-2 |
| Figure 7-3 | Configuration>Main Screen with All Control Modules Configured as Remote I/O | 7-3 |
| Figure 7-4 | Appearance of Operations Mode Screens when the All Control Modules Are Configured as <i>Remote I/O</i> | 7-4 |
| Figure 7-5 | Appearance of Operations Mode Screens when <i>EtherCAT</i> Is Selected for <i>External</i> <i>Communications</i> | 7-6 |
| Figure 7-6 | <i>EtherCAT</i> >Sweep Screen when Modify Enable Is ON..... | 7-7 |
| Figure 7-7 | <i>EtherCAT</i> >Sweep Screen, Modify Enable ON, User Modifying the Sweep Program..... | 7-7 |
| Figure 7-8 | Appearance of Operations Mode Screens when <i>RS-232</i> Is Selected for <i>External</i> <i>Communications</i> | 7-9 |
| Figure 7-9 | <i>RS-232</i> >Sweep Screen when Modify Enable Is ON..... | 7-10 |
| Figure 7-10 | <i>RS-232</i> >Sweep Screen, Modify Enable ON, User Modifying the Sweep Program..... | 7-10 |
| Figure 8-1 | Operations>Main Screen with Auxiliary Menu Displayed..... | 8-1 |
| Figure 8-2 | Diagnostics Screen, All Control Modules Configured as <i>Local</i> | 8-2 |
| Figure 8-3 | Diagnostics Screen When All Control Modules Are Configured as <i>Remote I/O</i> | 8-2 |
| Figure 8-4 | The Service>E-Beam Screen | 8-4 |
| Figure 8-5 | The Service>Sweep Screen..... | 8-5 |
| Figure 8-6 | The Service>Turret Screen | 8-5 |
| Figure 9-1 | Genius II Control PCBs Identified..... | 9-1 |
| Figure 9-2 | Unplugging the Upper Cable from the Indexer Control Module | 9-2 |
| Figure 9-3 | <i>EtherCAT</i> Connections Between Internal Genius II Components | 9-2 |
| Figure 9-4 | Unplugging the Upper Cable from the Indexer Control Module | 9-3 |
| Figure 9-5 | Removing the Control Module from the Genius II Chassis | 9-3 |
| Figure 9-6 | Installing the New Control Module | 9-4 |

| | | |
|-------------|--|-----|
| Figure 9-7 | Cutout in Bottom of Control Module | 9-4 |
| Figure 9-8 | Plugging Cables into the New Control Module | 9-5 |
| Figure 9-9 | Location of Hard Drive on Mother Board | 9-6 |
| Figure 9-10 | Removing the Hard Drive from the Mother Board | 9-6 |
| Figure 9-11 | Unplugging the Hard Drive Cable | 9-7 |
| Figure 9-12 | Plugging the Hard Drive Cable into the New Hard Drive | 9-7 |
| Figure 9-13 | Plugging the New Hard Drive into its Socket in the Mother Board | 9-8 |
| Figure B-1 | Connections: Genius II COM B Port to RS-232 Connector on Host Computer | 0-1 |

List of Tables

| <u>Table Number and Title</u> | <u>Page Number</u> |
|--|---------------------------|
| Table 2-1 Functional Descriptions of Pins on Rear Panel Connector X110 | 2-8 |
| Table 2-1 Functional Descriptions of Pins on Rear Panel Connector X119 | 2-10 |
| Table 6-1 Data Set Selection BCD Codes for a Four-Pocket Source | 6-6 |
| Table 6-2 Data Set Selection BCD Codes for a Six-Pocket Source | 6-7 |
| Table 6-3 Data Set Selection BCD Codes for an Eight-Pocket Source | 6-8 |
| Table A-1 Anybus Gateway Selection | A-1 |
| Table A-2 Memory Map: EtherCAT Interface for Genius II and EBC | A-2 |

Liability

The manufacturer's liability for the Genius II is based on the principles of German law. The manufacturer accepts no liability for damage and losses due to:

- improper use
- operation by unauthorised personnel
- failure to follow safety regulations
- failure to comply with the instructions in this manual.

Translation

If the machine is sold to a country in the EEA, this manual must be translated into the language of the country in which the machine is to be used. Should the translated text be unclear, the original manual (in English) must be consulted or the manufacturer contacted for clarification.

Intended Use

This manual is intended for all who may use or work on the Genius II controller, especially the operating personnel. The mounting instruction contains an exact description of the product, but does not warrant certain properties or success of use. The instruction handbook was inspected carefully before publication. The authors guarantee that the mounting instruction does not contain errors that cancel or reduce the value or suitability of the device for its intended use. The publishers, however, accept neither explicitly nor implicitly any liability for damage or consequential losses resulting from use of this manual. We are thankful for notification of errors and for recommendations and criticism. Where not stated otherwise, the technical state at the time of joint delivery of product and manual is definitive. We reserve the right to make technical changes without prior notice. All previous revisions of this manual then lose their validity.

The Genius II controller is part of a group of devices for the operation of an electron beam evaporator installed in a vacuum chamber. This group of devices consists of:

1. a high voltage power supply (HVPS)
2. the Genius II controller, including hand-held remote control
3. a filament power supply (FPS)
4. a grounding rod

Use of the Genius II controller other than in combination with this group of devices is not allowed. The Genius II is intended solely for the control of this group of devices. Use of the Genius II for any other purpose requires the approval of the manufacturer. This Manual deals only with the design and operation of the Genius II. Please see the relevant user manuals regarding operation of the other devices in the group. These devices were developed, designed, and built solely for commercial/industrial use. Proper use in accordance with its designated use includes compliance with the manufacturer's operating, maintenance, and repair instruction.



WARNING!

Access to the electron beam evaporator is to be secured by the unit controller in such a way that it is possible to ensure that both the rotary crucible movement and the high-voltage power supply are stopped. To this end, external connection options are available at the high-voltage supply and at the Genius II controller. The person setting up the entire unit is required to integrate this safety function in accordance with the performance level determined in the functional safety.



DANGER!

The evaporation controller Genius II is intended solely for the purpose described above. Any other use or modification of the evaporation controller Genius II without the written consent of the manufacturer is deemed improper. The manufacturer accepts no liability for resultant damage. The risk is borne solely by the operator.

NOTICE

Per EMC Directive 2004/108/EG in the manufacturer's declaration, the Genius II controller may be operated only in Industrial environments.



DANGER!

The materials/media required for operation of the electron beam evaporator in compliance with its intended use are procured and used by the operator of the electron beam evaporator. Proper handling of these materials/media and the related dangers are the sole responsibility of the operator. The operator must supply his operating personnel with information and instructions on dangers and disposal. The safety data sheets of the material/media manufacturers must be observed

Copyright

No part of this publication may be reproduced, transmitted, sold or disclosed without prior permission. Damages will be claimed for violations. All rights reserved. The controller and this manual are protected by copyright. Copying of the devices will be prosecuted. All rights to this manual are reserved, including reproduction in any conceivable form, be it photo mechanical, by printing, on any data carrier whatsoever or in translated form. Reproduction of this manual, also in excerpts, is permitted only with the written consent of Ferrotec GmbH.

Publisher

Should you have any questions or problems the installation or initial operation of the Genius II, please contact us. We will be glad to help you.

Ferrotec GmbH
Seerosenstrasse 1
72669 Unterensingen
phone +49 7022 9270-0
fax +49 7022 9270-10

Explanations of Safety Symbols and Notifications



DANGER!

Warns of dangerous actions situations that could result in severe injury or death. Avoid such actions and situations.

CAUTION

Warns of actions that could lead to damage to the Genius II or other equipment associated with the evaporation system. Avoid such actions.



Indicates danger of burns .



Indicates danger of hands being crushed or injured.



Indicates danger from magnetism.



Indicates danger to people with cardiac pacemakers, people with insulin pumps, and people with active or passive prostheses and ferromagnetic or conductive foreign bodies.



These symbols mark the sites of protective conductor connections.



Environment sign indicates actions to protect the environment.



This symbol reminds personnel to wear personal safety equipment, including safety glasses.



This instruction handbook is an integral part of the deposition controller and must be kept readily at hand for the operating personnel at all times. The safety instructions contained in it must be obeyed. If the deposition controller is resold, the instruction handbook must always be delivered along with it.

Manufacturer's Warranty

Conditions of the warranty

FerroTec products are produced and inspected in accordance with our quality management system. Warranty must be claimed immediately after the notice of the failure including the serial number of the deposition controller. The manufacturer guarantees warranty of the product of 12 months to be free on defects caused by material failure or failures caused by the manufacturing process. If a fault occurs during this time period the manufacturer guarantees free of charge repair in regards of parts and labor time.

Warranty exclusions

Damages caused by improper or not intended use or unauthorized alterations into the Genius II are excluded from this warranty.

1

Introduction to the Genius II Controller

1.1 Section Overview

This section provides a physical description of the Genius II and overviews of how its user interfaces operate. The topics covered are:

Section 1.2 Product Description

Section 1.2.1 Hardware Applications and Functional Capabilities

Section 1.2.2 Main Components

Section 1.3 The Main Controller's Touch Screen

Section 1.3.1 Functional Overview of Touch Screen

Section 1.3.2 The Main and Auxiliary Menus

Section 1.4 Control/Display Features of Remote Controller

Section 1.4.1 The Remote Controller's LCD Screen

Section 1.4.2 Command/Function Selection Buttons

Section 1.4.3 The Joystick

Section 1.5 Genius II Operating Modes

Section 1.5.1 Configuration Mode

Section 1.5.2 Operations Mode

Section 1.5.3 Manual Mode

Section 1.5.4 Service Mode

Section 1.6 Main Controller Screens Accessible in Multiple Modes

1.2 Product Description

1.2.1 Hardware Applications and Functional Capabilities

The Genius II is a rack-mountable unit designed to control three or more components in an e-beam deposition system. In its current configuration, the Genius II enables control in any of four operating modes over the following devices/functions:

- Carrera HVP3, HPV5, HVP6, and HVP10 e-beam power supplies
- rotation of any compatible e-beam source with 4, 6, 8, 10 or 12 pockets as well as 'skillet'-type turret sources
- E-beam sources with max. +/-3 A deflection coil current output in both X and Y axes.

The Genius II enables the user to define beam position limits and to design and store up to 10 sweep programs per pocket. Programmable sweep parameters include frequency in X and Y axes, amplitude in X and Y axes, and waveform in X and Y axes. Available sweep waveforms are sine, clipped, sawtooth, ramped, and arbitrary.

1.2.2 Main Components

The main components of the Genius II are its rack-mountable main control unit and its hand-held remote controller. Figures 1-1 and 1-2 illustrate features of the Genius II front panel and remote controller, respectively. The rear-panel features are illustrated and described in detail in section 2.3.

The Genius II Main Control Unit

The front panel of the Genius II main controller includes its control touch-screen, an On/Off button, a connection port for the hand-held remote controller, and two USB ports.

Figure 1-1 Genius II Front Panel

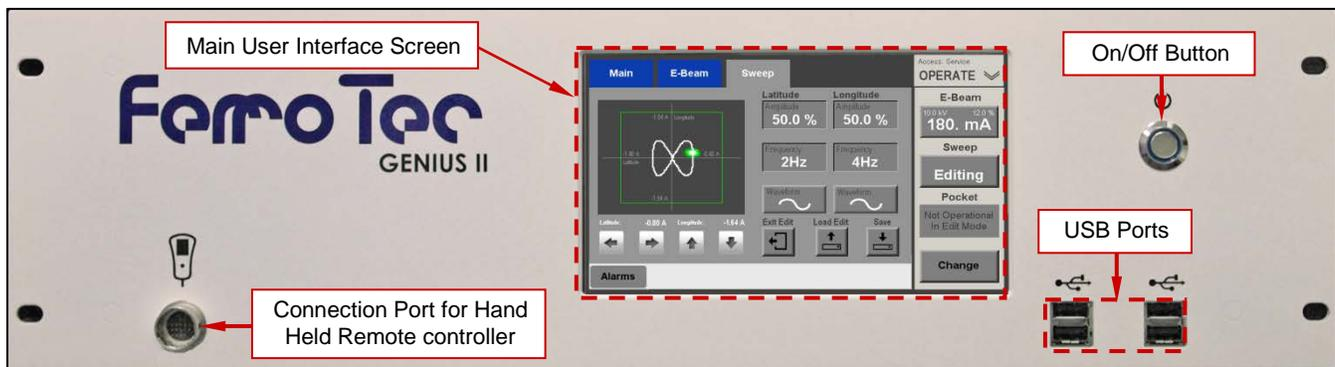

For a detailed functional description of the main UI screen, see section 1.3.1.

Hand-Held Remote Controller

The main function of the hand-held remote controller is to enable the user to configure sweep patterns while observing actual beam motion through a viewport. The control/display features of the hand-held controller (see Figure 1-2) are:

- the LCD display
- five command buttons, whose functions vary depending on which screen is currently displayed on the LCD screen
- a joystick that allows the user to control e-beam power, beam spot position (or the sweep pattern's center point), turret jogging, and sweep amplitude and frequency.

For detailed information about the functions of these remote controller features, see section 1.4.

Figure 1-2 Control/Display Features of Hand Held Remote Controller

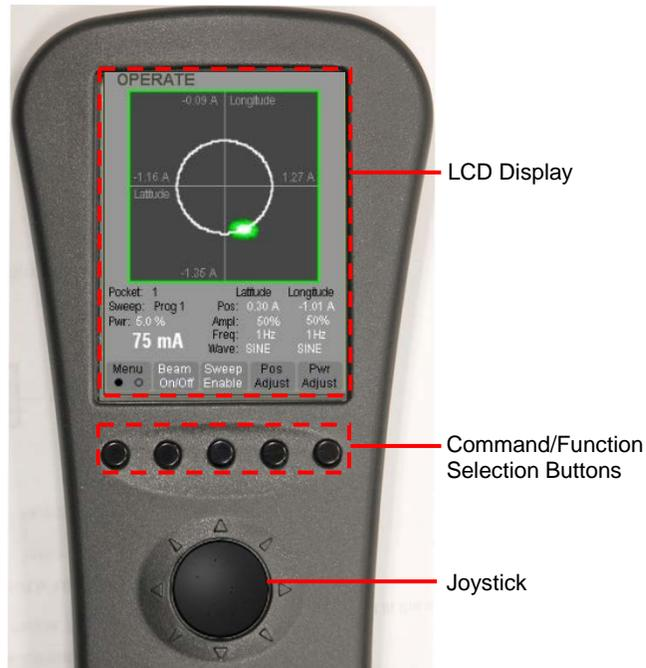

1.3 The Main Controller's Touch Screen

1.3.1 Functional Overview of Touch Screen

Figure 1-3 identifies the functionally distinct areas of the touch screen, which are described in detail in section 4.6.

Figure 1-3 Functionally Distinct Areas of Main UI Screen

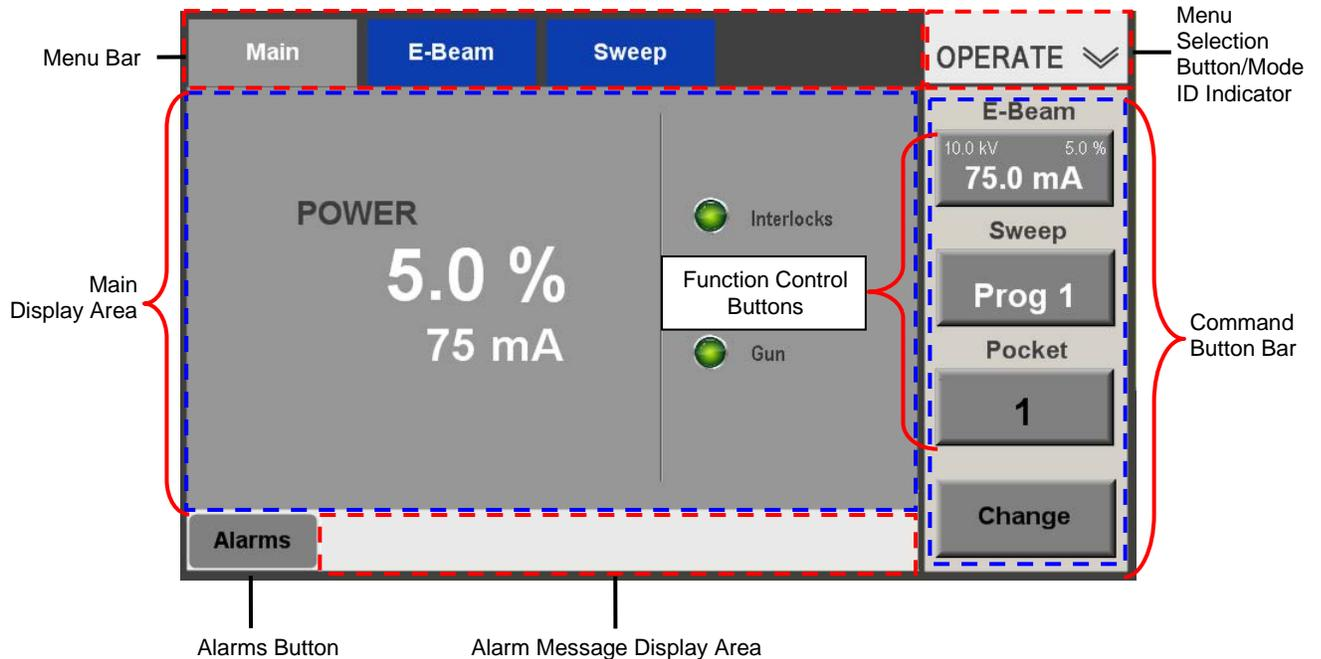

1.3.2 The Main and Auxiliary Menus

The Menu Bar can display either the Main Menu (see Figure 1-3) or the Auxiliary Menu (see Figure 1-4). The Main Menu allows the user to display any of the screens that are unique to the operating mode currently selected. The Auxiliary Menu enables the user to log off, to switch operating modes and, in all modes except Service, to Display the Diagnostics screen (see Figure 1-14).

Figure 1-4 Operations>Main Screen with Auxiliary Menu Displayed



1.4 Control/Display Features of Remote Controller

1.4.1 The Remote Controller's LCD Screen

The screens displayed on the remote controller vary depending on which Genius II operating mode is currently selected. When Configuration mode is selected, the user can select either of two menus (see Figure 1-5). When either Operations or Manual mode is selected and all control modules are configured as Local, the user can select either of the menus shown in Figure 1-6.

Figure 1-5 Remote Controller Screens Available in Configuration Mode

Menu 1 Selected

Menu 2 Selected



Figure 1-6 Remote Ctr. Screens in Ops Mode, All Control Modules Configured as Local

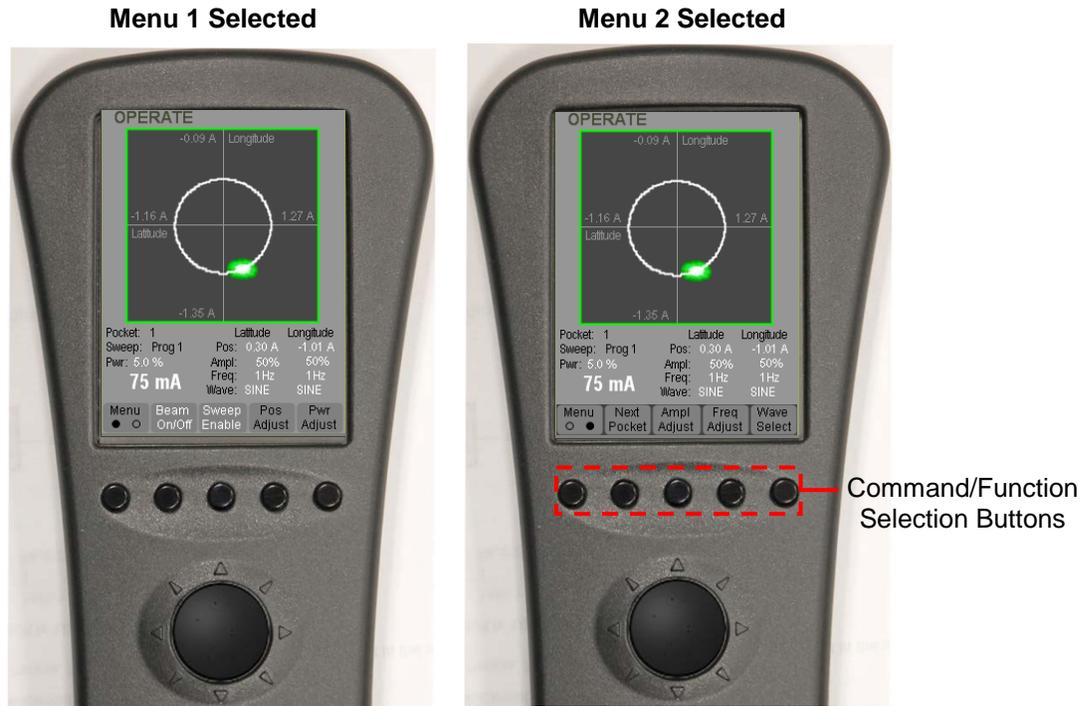

For information about using the remote controller in Configuration Mode, see Section 3.7.5. For details regarding remote controller use in Operations Mode when all control modules are configured as **Local**, see section 5.7. When a given command module is configured as **Remote I/O**, **EtherCAT**, or **RS232**, the remote controller features related to that control module are display-only; no command functions related to that command module are active. When the Genius II is in Manual mode, the remote controller's control features function as they do when the unit is in Operations mode with all control modules configured as **Local**.

1.4.2 Command/Function Selection Buttons

The remote controller's command buttons (see Figure 1-6) include a **Menu** button and four other buttons. The functions available via those four buttons vary depend on whether the unit is in Configuration or Operations Mode and which menu is selected via the remote controller's **Menu** button. When the Genius II is in Configuration Mode, clicking the **Menu** button toggles the display between Menus 1 and 2 (see Figure 1-5). When the Genius II is in either Operations mode (with all control modules configured as **Local**) or Manual mode, clicking the remote controller's **Menu** button toggles the unit between the two menus shown in see Figure 1-6.

Each of the other four command buttons enables the user either to select the function identified directly above it on the menu currently displayed. For further information about the functioning of these buttons in Configuration mode, see section 3.7.5. For complete details about their functions in and Operations and Manual modes, see section 5.7.

1.4.3 The Joystick

The remote controller’s joystick enables the user to:

- vary beam power
- rotate the turret to the next pocket.
- move the beam spot/sweep pattern center
- in Operations and Manual modes, adjust sweep amplitude and frequency and enable/disable the sweep
- in Configuration mode, jog the turret

For detailed information about the joystick’s functions in Configuration and Operations Modes, see Sections 3 and 5.7, respectively.

1.5 Genius II Operating Modes

The Genius II’s operating modes are Configuration Mode, Operations Mode, Manual Mode, and Service Mode. Genius II operation in each of these modes is described briefly below and in detail in Sections 3 through 8.

1.5.1 Configuration Mode

Figure 1-7 shows the Configuration Mode screens. The main function of Configuration Mode is to enable the user to configure parameters related to the e-beam power supply and turret rotation and to set beam-position interlock limits. Configuration Mode also screens allow the user to:

- configure deposition profiles
- enable the log-in manager and assign user passwords and permissions
- set the system date and time

For detailed information about Genius II operation in Configuration mode, see Section 3.

Figure 1-7 Configuration Mode Screens (All Control Modules Configured as Local)

Config>Main Screen

Login Manager Screen, Login Manager Enabled

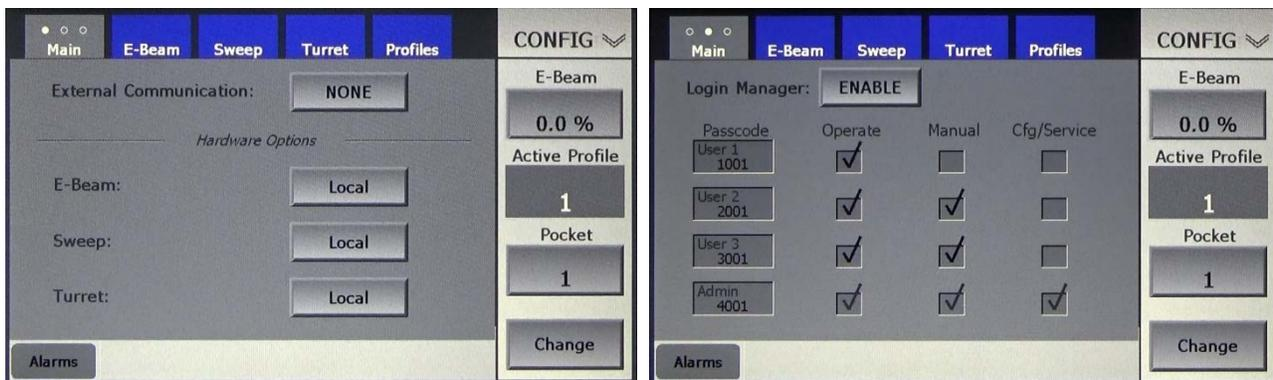

System Date/Time Screen



Config>E-Beam Screen

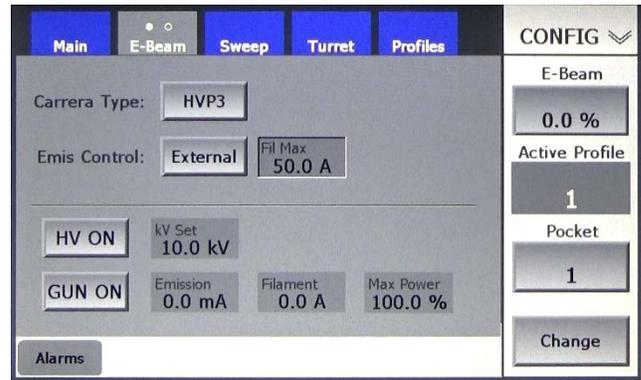

Emission Response Tuning Page

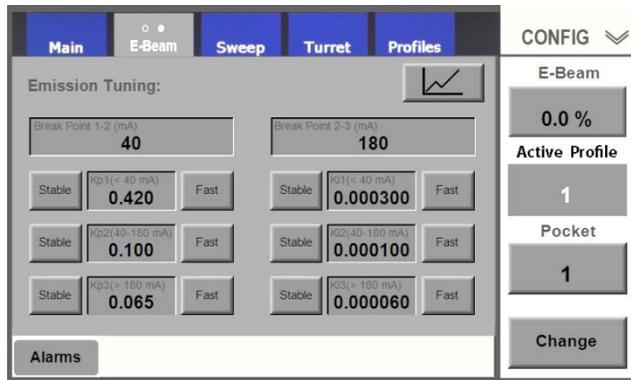

Emission Response Graph Page

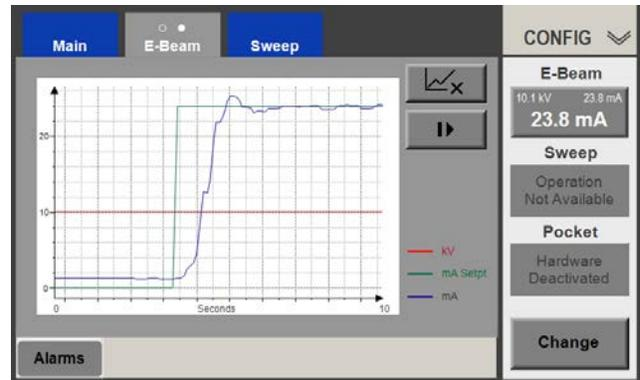

Config>Sweep Screen

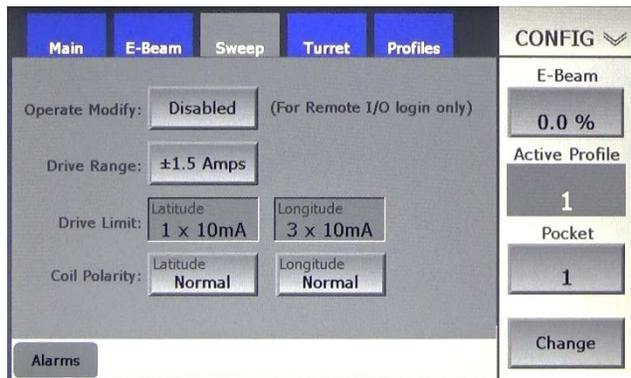

Config>Turret Screen

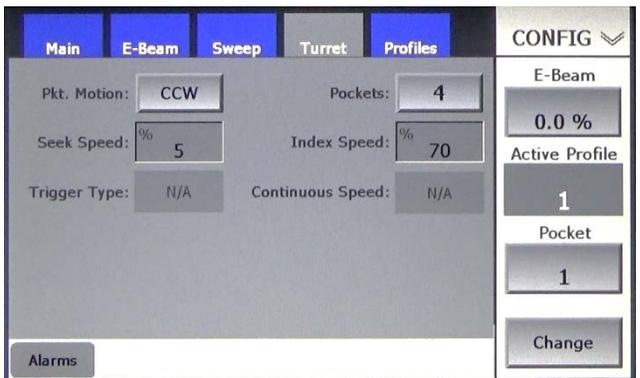

Profiles Page 1

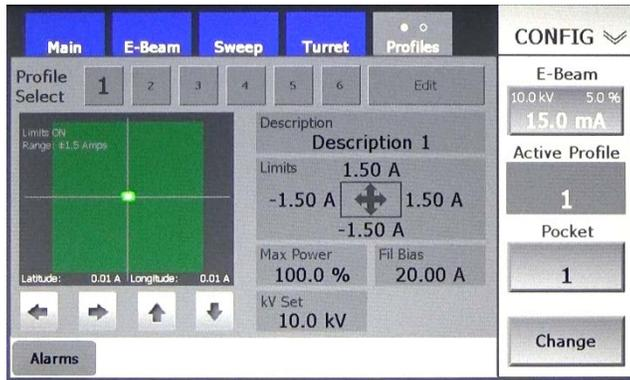

Profiles Page 2

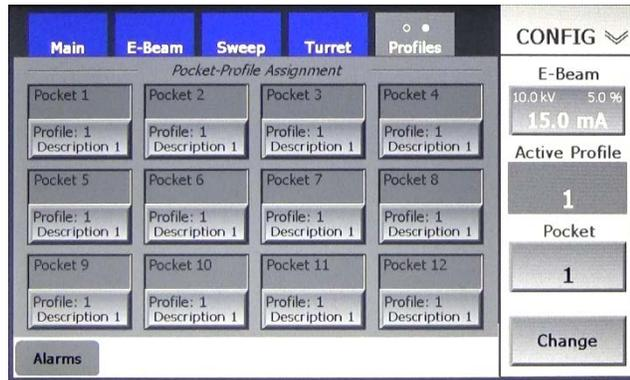

1.5.2 Operations Mode

Operations Mode Screens When All Control Modules Are Configured as Local

Figure 1-8 shows the Operations mode screens as they appear when all control modules are configured as **Local**. For detailed information about Genius II Operation under these conditions, see Section 5.

Figure 1-8 Operations Mode Screens when all Control Modules Are Configured as Local

Operations>Main Screen



Operations>E-Beam Screen



Operations>Sweep Screen

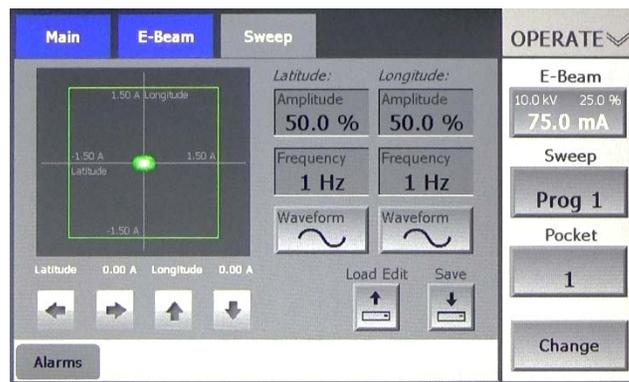

Operations Mode Screens When All Control Modules Are Configured as EtherCAT

Figure 1-9 shows the Operations mode screens when **EtherCAT** is selected for **External Communications**. When that selection is made, all three control modules are automatically configured as **EtherCAT**, which means that they are controlled by EtherCAT inputs from a PLC-based system controller. When the unit is configured this way, all Operations mode control buttons become flat display rectangles, as shown below, except when the system controller asserts the Modify Enable signal. For more information on Genius II operation in Operations mode when **EtherCAT** is selected, see section 7.3.

Figure 1-9 Operations Mode Screens When All Control Modules Are Configured as EtherCAT



Operations Mode Screens When All Control Modules Are Configured as RS-232

Figure 1-10 shows the Operations mode screens when **RS-232** is selected for **External Communications**, in which case all three control modules are automatically configured as **RS-232**, putting them under the control of a PLC-based system controller. When the unit is configured this way, all Operations mode control buttons become flat display rectangles, as shown below, except when the system controller asserts the Modify Enable signal. For more information on Genius II operation in Operations mode when **RS-232** is selected, see section 7.4.

Figure 1-10 Operations Mode Screens When All Control Modules Are Configured as RS-232

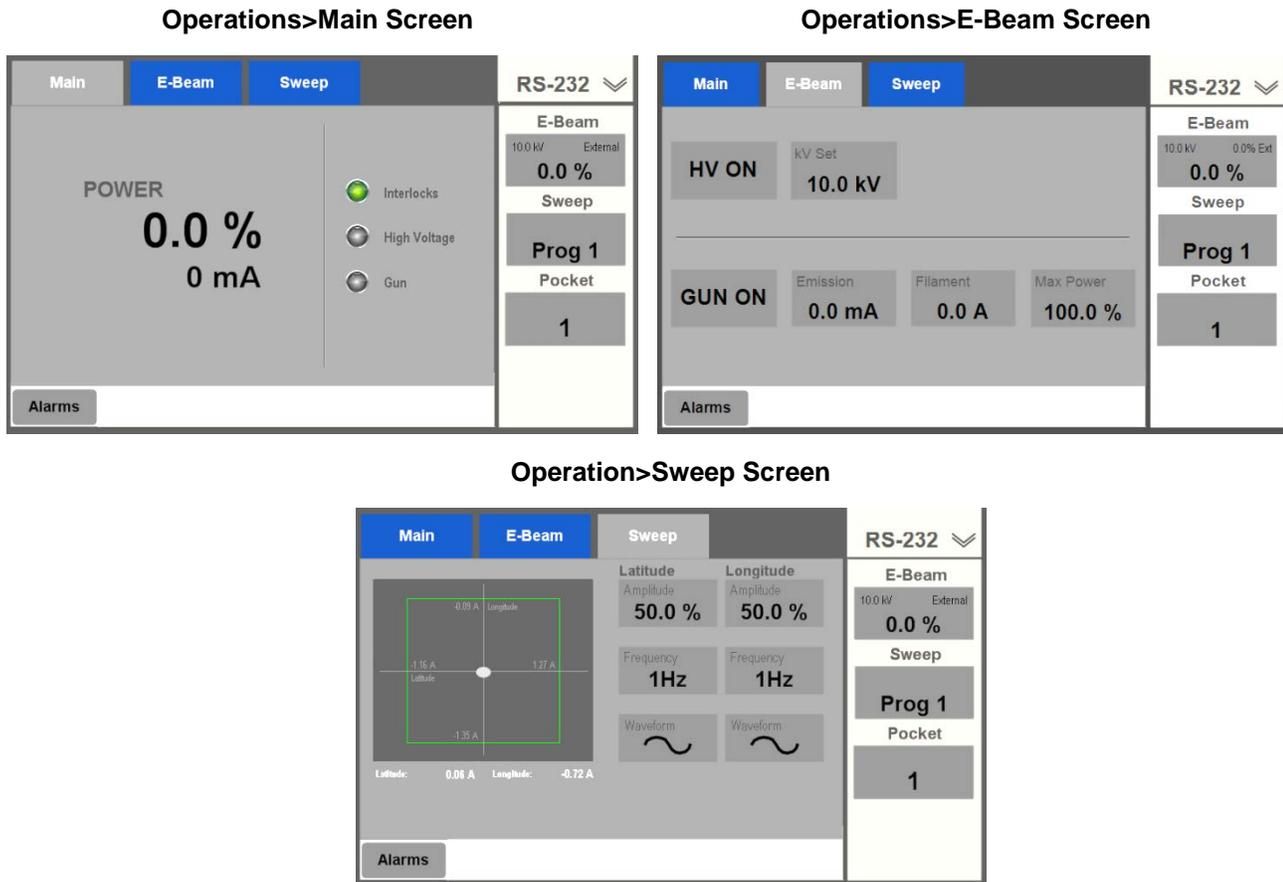

1.5.3 Manual Mode

Figure 1-11 shows the Manual mode screens, which allows an operator to operate the unit from its UI when one or more control modules are configured as **Remote I/O**, **EtherCAT**, or **RS-232**. Selection of Manual Mode local control over all control functions and locks out all control inputs from a higher-level controller, whether a deposition controller or a PLC-based system controller. In Manual mode, the Genius II operates exactly as it does in Operations mode when all control modules are configured as Local and **Internal** is selected for **Emis Control**. Manual mode is particularly convenient for predeposition material conditioning when the unit is configured for control by a higher-level controller.

Figure 1-11 Manual Mode Screens

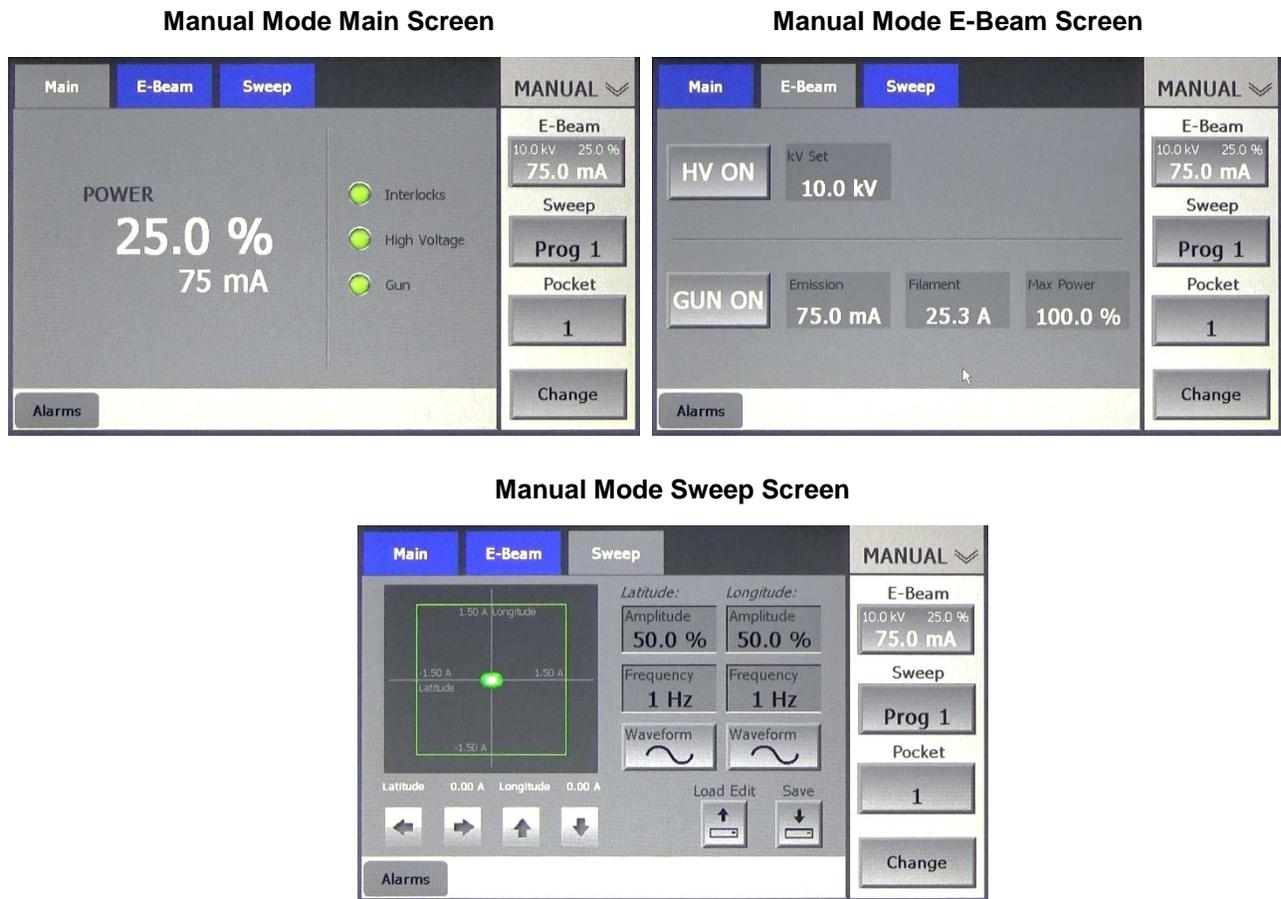

1.5.4 Service Mode

Figure 1-12 shows the Service Mode screens. The Service>E-Beam, Service>Sweep, and Service>Turret screens enable the user to test individual outputs. In addition, those screens display the True/False status of inputs from the controlled devices and the status of inputs from a higher-level controller, if the Genius II is connected to such a controller. For detailed information about Service mode screens, see section 8.3.

Figure 1-12 Service Mode Screens

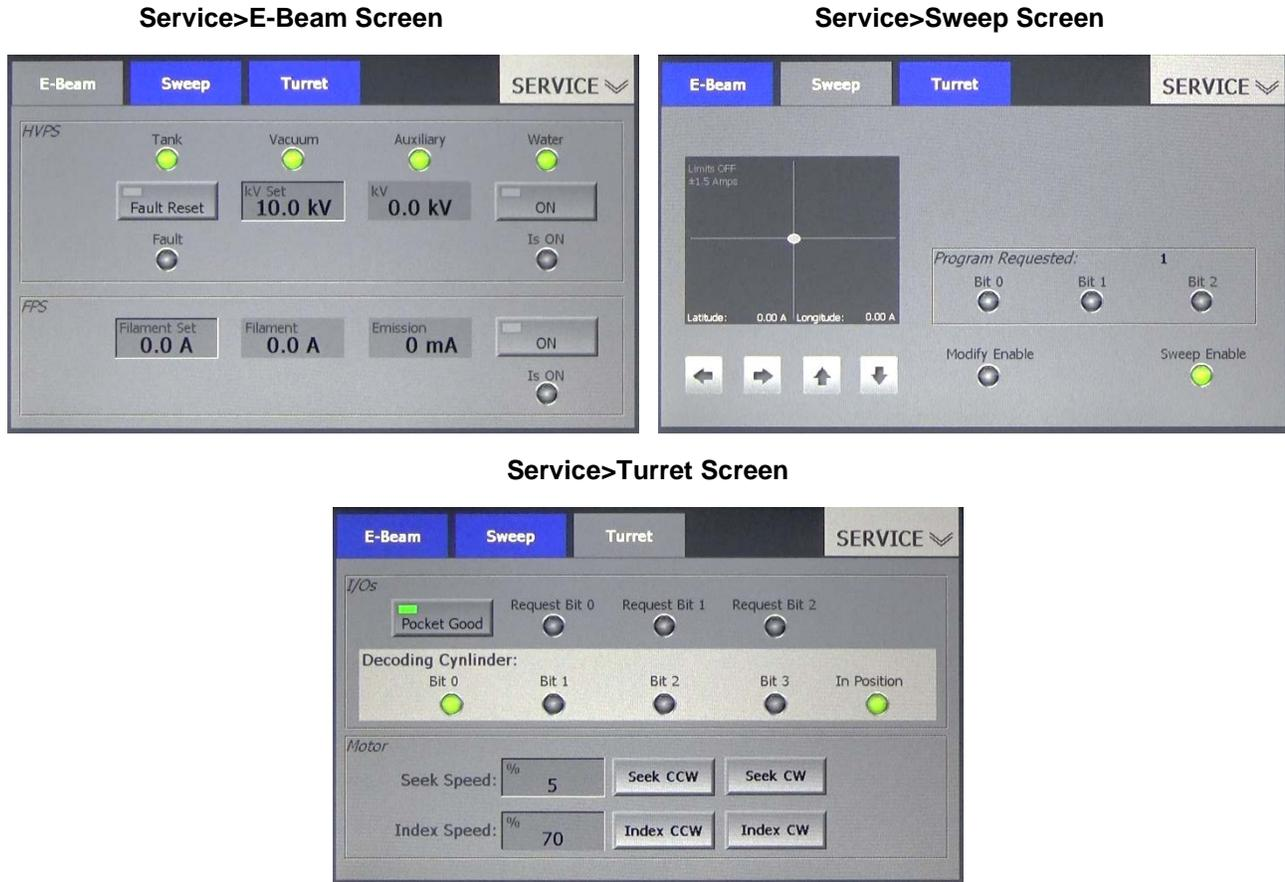

1.6 Main Controller Screens Accessible in Multiple Modes

Three Genius II main controller screens are available in multiple operating modes. These are the Alarms screen (see Figure 1-13), the Diagnostics screen (see Figures 1-14 and 1-15), and the Language Selection/Software Version ID screen (see **Error! Reference source not found.**).

The Alarms and Diagnostics Screens

The Alarms and Diagnostics screens are available in all Genius II operating modes except for Service Mode. For information about the Alarms screen and procedures for responding to alarms, see section 4.5. For detailed information about the Diagnostics screen, see section 8.2.

Figure 1-13 The Alarms Screen



Figure 1-14 The Diagnostics Screen, All Control Modules Configured as Local

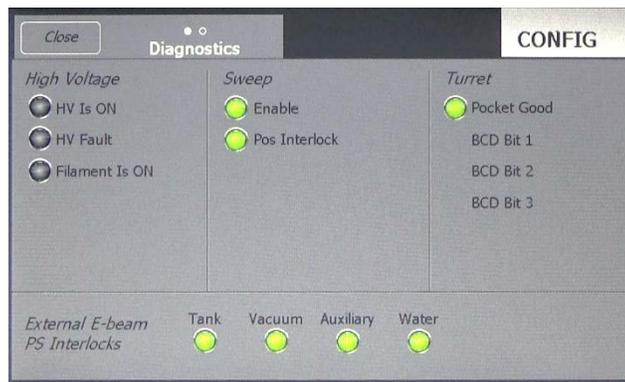

Figure 1-15 The Diagnostics Screen, All Control Modules Configured as Remote I/O



The Language Selection/Software Version ID Screen

The Language Selection/Software Version ID screen (see Figure 1-16) permits the selection of Russian instead of English in the Genius II user interface. It also identifies the software version of your unit's main processor and the firmware versions of the HVPS, FPS, Sweep, and Turret control modules. It is accessed by touching the dots above the label **Diagnostics** when the diagnostics screen is displayed.

Figure 1-16 The Language Selection/Software Version ID Screen

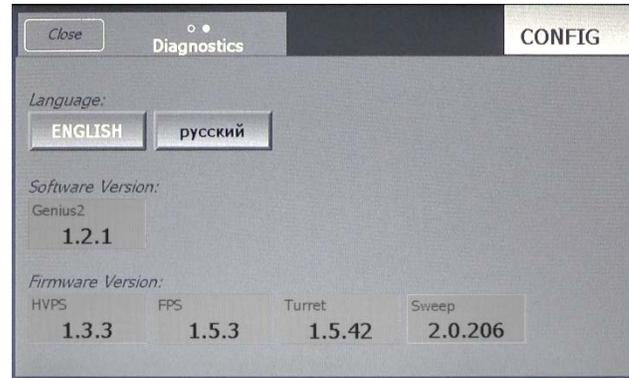

2.1 Section Overview

This section describes the installation of the Genius II. Included are cabling instructions for installing the unit as a stand-alone controller as well as instructions for connecting the Genius II to higher-level controllers (i.e., a deposition controller and, optionally, a PLC-based system controller. The topics covered are:

Section 2.2 Basic Hardware Installation

Section 2.2.1 Rack Mount the Genius II Main Controller

Section 2.2.2 Connect the Hand-Held Remote Controller

Section 2.3 Making Cable Connections in to Components Controlled by the Genius II

Section 2.3.1 Cabling Overview

Section 2.3.2 Basic Cabling Procedure

Section 2.4 Making Connections to Higher Level Controllers

Section 2.4.1 Making Connections to Rear Panel Connector X110

Section 2.4.2 Making Connections to Rear Panel Connector X119

Section 2.5 Connecting the AC Power Cable and Powering Up the Genius II

2.2 Basic Hardware Installation

2.2.1 Rack Mount the Genius II Main Controller

Using the mounting hardware supplied, install the Genius II controller in a standard 19-inch rack.

2.2.2 Connect the Hand-Held Remote Controller

Plug the connector on the end of the remote controller's cable into the port indicated in Figure 2-1.

Figure 2-1 Genius II Front Panel, Showing Connections Port for Hand Held Remote Controller



2.3 Making Cable Connections in to Components Controlled by the Genius II

2.3.1 Cabling Overview

Section 2.3.2 describes how make cable connections between the Genius II and controlled components and how to make the required connections to interlock switches. For a detailed illustration of these cabling connections, see Figure 2-3. For instructions on making connections between the Genius II and higher-level controllers (i.e., a deposition controller and, optionally, a PLC-based system controller), see section 2.4.

WARNING

Connect the Genius II's rear panel SWEEPER COILS connector only to e-beam guns with beam-drive coils of ± 3 A capacity in both the longitudinal and lateral axes.

2.3.2 Basic Cabling Procedure

The following procedure describes how to connect the Genius II to the components it controls and to the required interlock switches. Figure 2-2 shows the connectors on the Genius II rear panel.

Figure 2-2 Genius II Rear Panel Connectors

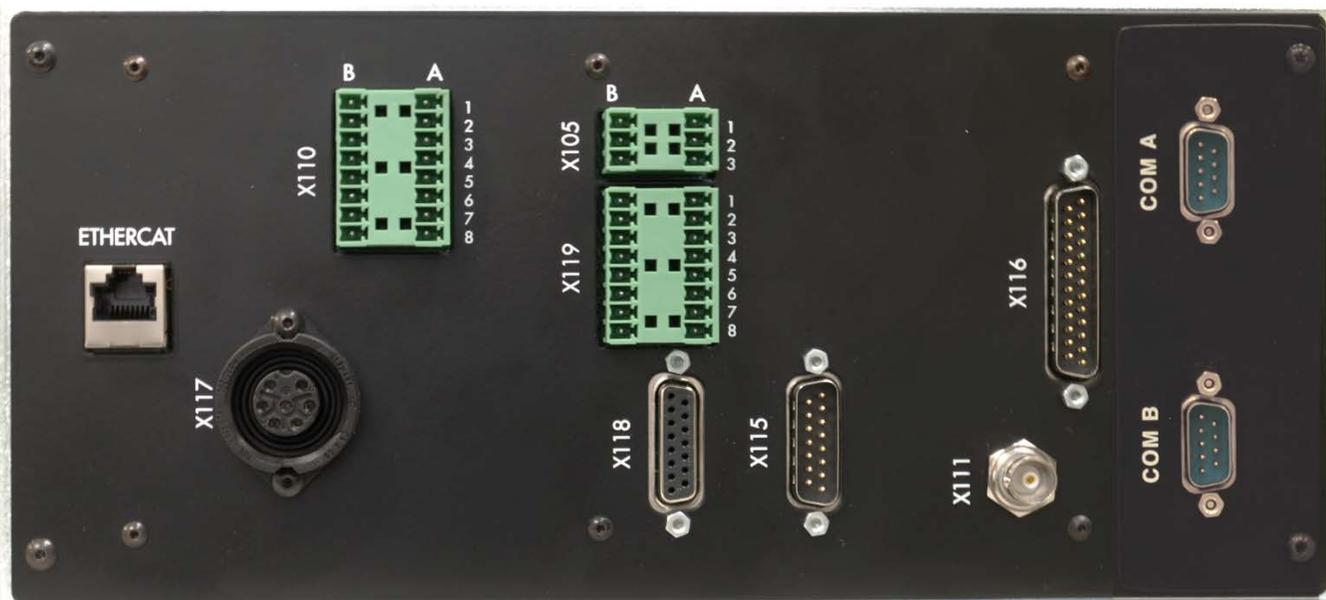

| Step | Action |
|------|---|
| 1 | Cable 1-950040 is a Y-cable whose Y-end connectors plug into Carrera rear-panel connectors X302 and X302. |
| 2 | Plug the female 15-pin connector on the other end of this cable to the Genius II rear panel connector X115. |

- 3 Plug the female 25-pin sub-D connector on one end of cable 1-950013 into Genius II rear-panel connector X116.
- 4 Plug the male connector on the other end of this cable to connector X202 on the rear panel of the filament power supply.
- 5 Plug the circular connector on one end of the cable 1-950003 to connector X117 on the Genius II rear panel.
- 6 Plug the circular connector on the other end of this cable to the in-atmosphere end of octal feedthrough mounted on the vacuum system's source tray.
- 7 Plug the male 15-pin connector on one end of cable 1-950054 into Genius II rear panel connector X118.
- 8 Connect the female 15-pin sub-D connector on the other end of this cable to the male 15-pin connector on the turret-drive unit mounted beneath the source tray.
- 9 Connect the grounding cable (PN 1-9500001) to the grounding stud on the Genius II rear panel (see Figure 2-3).
- 10 Connect the required water, vacuum, and vacuum chamber door interlock switches to Genius II rear-panel connector X110, as shown in Figure 2-4.

Figure 2-3 Genius II Cabling Diagram

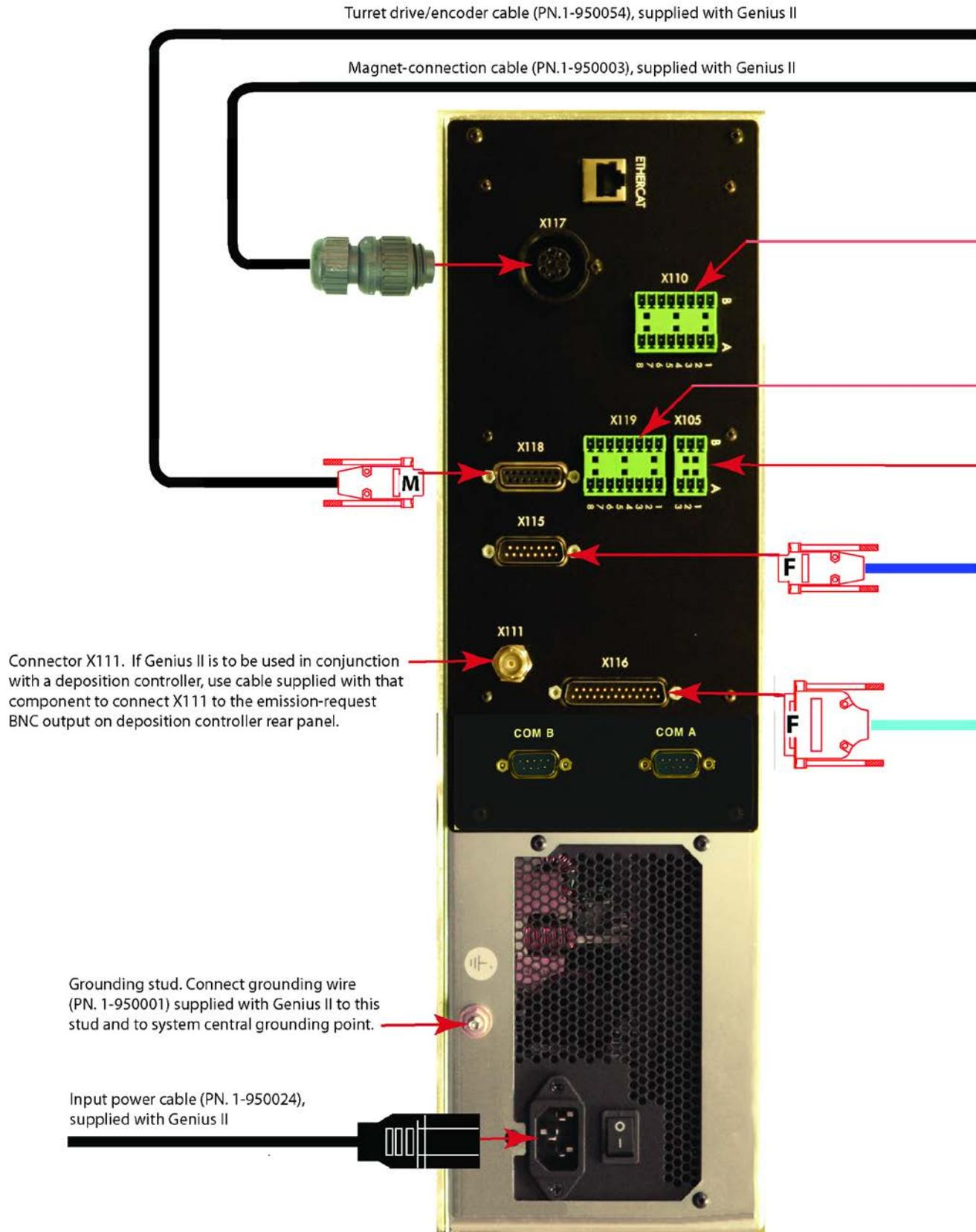

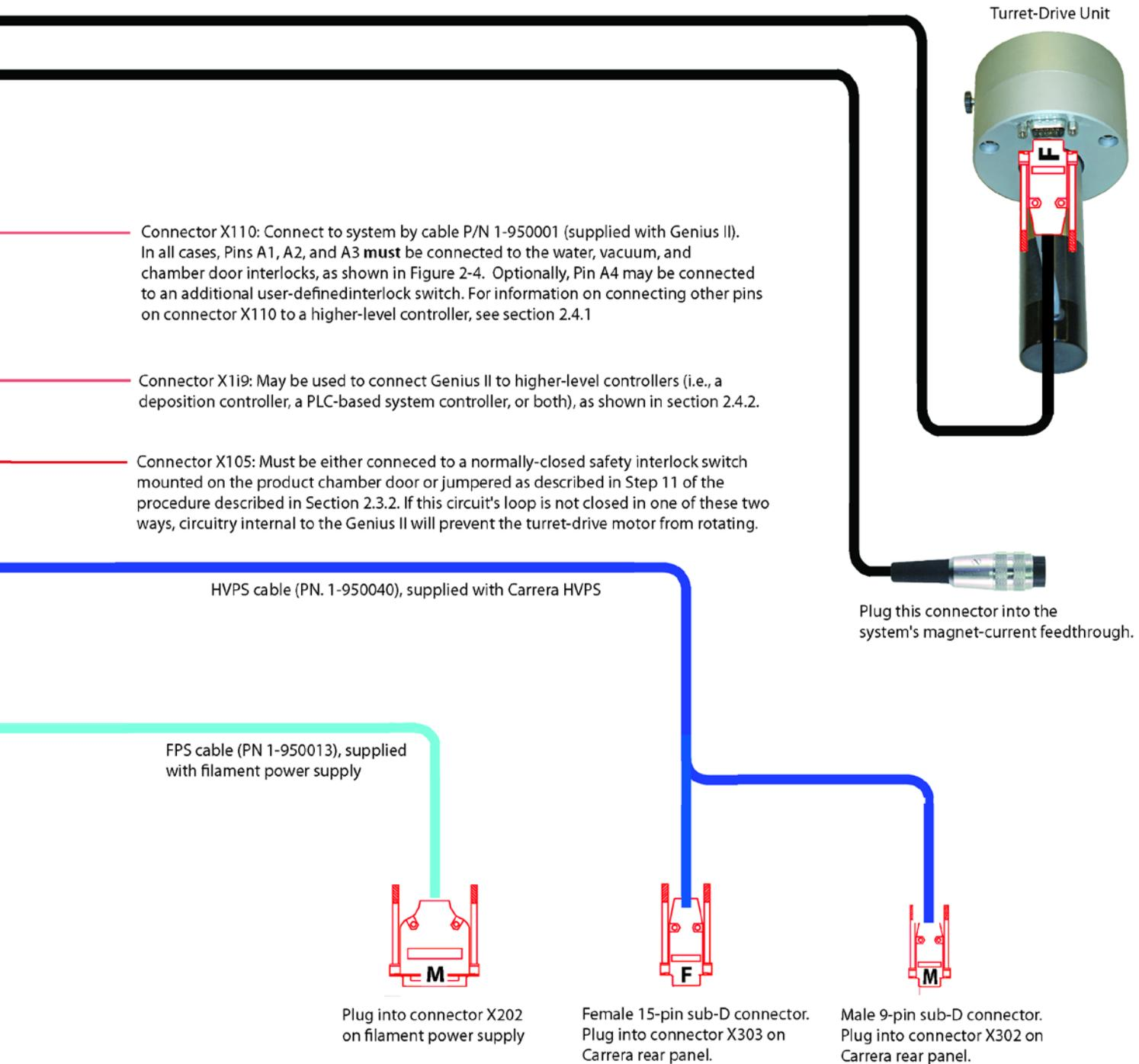

NOTE

To ensure equipment and personnel safety, these interlock switch connections are required in all Genius II installations. Optionally, Pin A4 may be connected to an additional user-defined interlock, as shown in Figure 2-4.

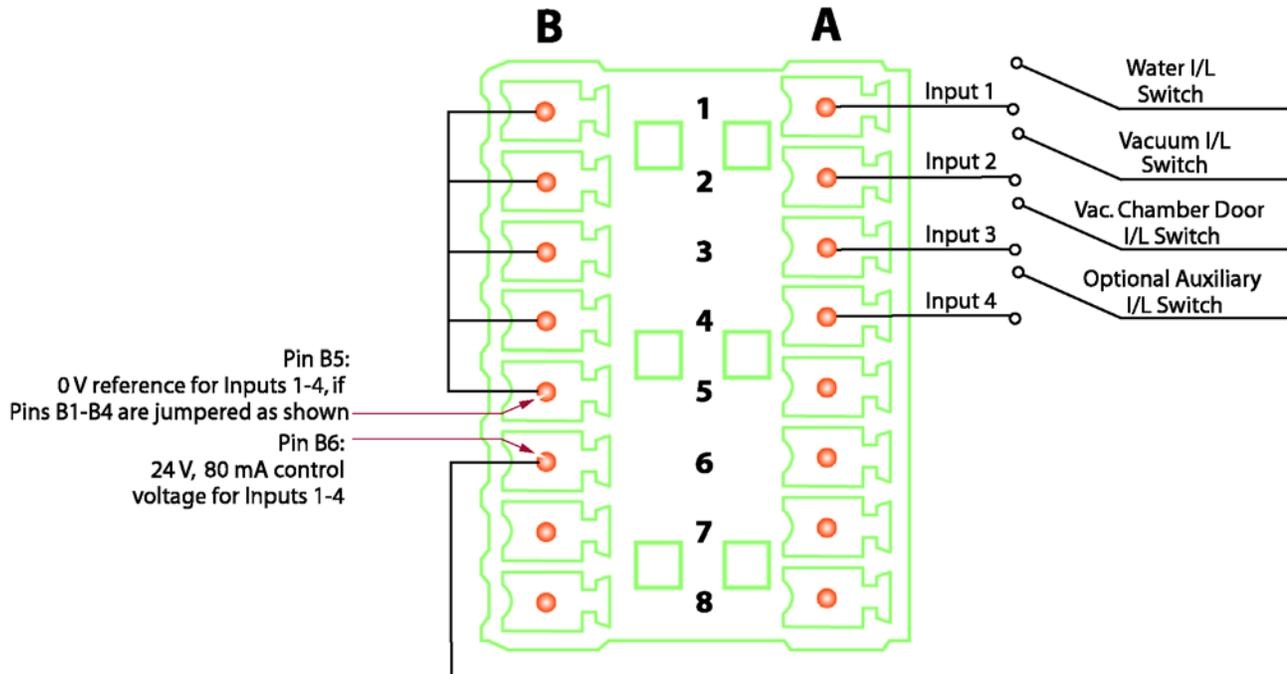
Figure 2-4 Required Interlock Connections to Rear Panel X110

- 11 Make the required connectors to rear-panel connector X105. These connections vary depending on whether or not you are implementing a connection between X105 and a normally-closed safety switch mounted on the product chamber door.

If a PC door interlock switch is implemented, it must be connected to the connector X105 in such a way that turret rotation is prevented when the PC door is open. Figures 2-5 and 2-6 show two different ways making the required connections, depending on the source of the 24 VDC power used to energize that switch. Figure 2-5 shows the connections required if the interlock switch is energized by 24 VDC power supplied by the Genius II. Figure 2-6 shows the connections required if the switch is energized by a 24 VDC power source supplied from elsewhere in the system.

If the Genius II is not connected to a product chamber door interlock switch, rear panel connector X105 must be jumpered as shown in Figure 2-7.

CAUTION

Users implementing a PC door interlock switch configured as shown in either Figure 2-5 and or Figure 2-6 are strongly advised to add a 0.5 A fuse as shown in the diagrams. Doing so protects internal PC boards against possible transient voltages.

Figure 2-5 Connector X015 Connected to a Product Chamber Door Interlock Switch Energized by 24 VDC Power Supplied by the Genius II

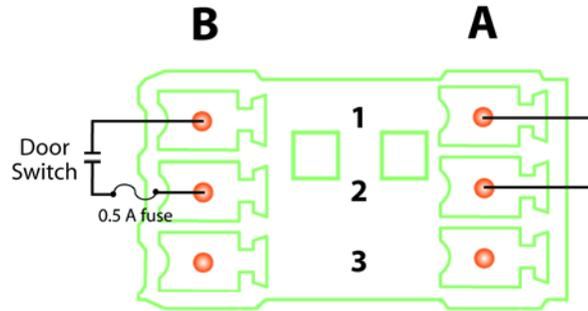

Figure 2-6 Connector X105 Connected to a Product Chamber Door Interlock Switch Energized by an External 24 VDC Power Supply

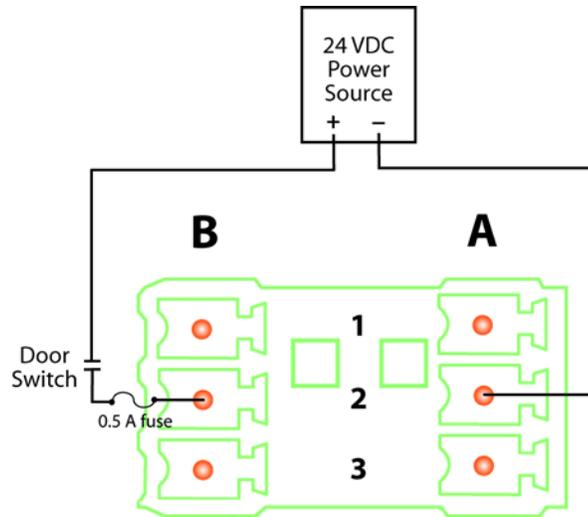
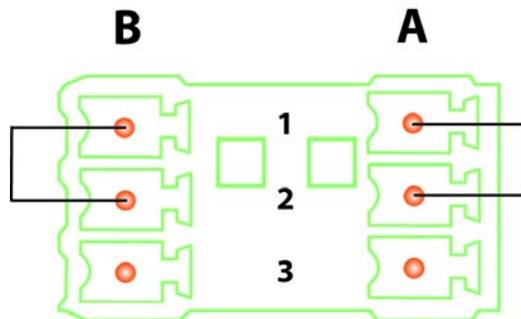

Figure 2-7 Connector X105 Jumpered as Required When Not Connected to a Product Chamber Door Interlock Switch



NOTE

If an interlock switch is not connected as shown in either Figure 2-5 or Figure 2-6, then connector X105 must be jumpered as shown in Figure 2-7. If X105 is not jumpered that way under those conditions, the turret will not rotate at all.

2.4 Making Connections to Higher Level Controllers

2.4.1 Making Connections to Rear Panel Connector X110

When making connections between rear panel connector and a deposition controller, perform the procedure described below.

NOTE

Before performing this procedure, complete the basic cabling procedure described in section 2.3.2

- | Step | Action |
|------|---|
| 1 | Using the BNC cable provided with the deposition controller, connect Genius II rear-panel connector X111 to the BNC connector on the deposition controller rear panel that outputs the emission current request. If you are connecting the Genius II to either an Inficon XTC/3S or XTC/3M, connect the BNC connector to the deposition controller's SOURCE 1 connector. If a BNC cable is not supplied with the deposition controller, use a standard 50-ohm coaxial cable. |
| 2 | Make connections shown in Figure 2-8 between the higher-level controller(s) and Genius II rear panel connector X110 rear-panel. Table 2-1 provides functional definitions of the I/Os shown in the illustration. |

Figure 2-8 Connections to Rear Panel Connector X110, Genius II Connected to Deposition Controller

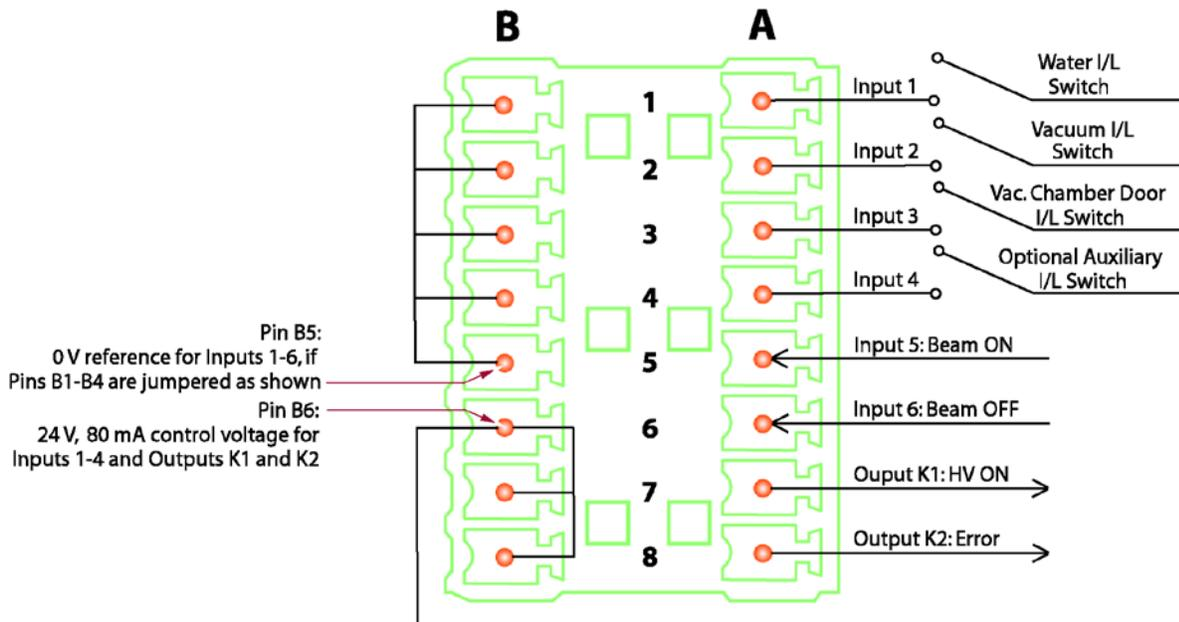
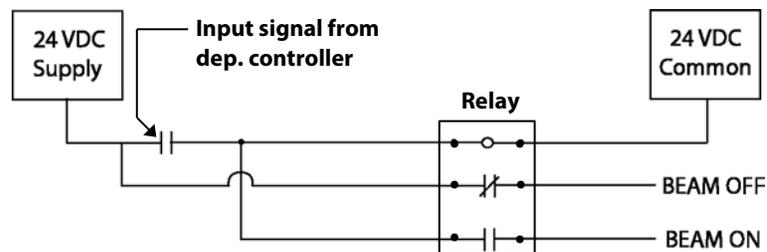

Table 2-1 Functional Descriptions of Pins on Rear Panel Connector X110

| Pin No. | Functional Description |
|---------|--|
| A1 | Input 1: Status of water interlock (1 = OK); connect to water interlock switch. |
| A2 | Input 2: Status of vacuum interlock (1 = OK); connect to vacuum interlock switch. |
| A3 | Input 3: Status of vacuum chamber door interlock (1 = OK); connect to vacuum chamber door interlock switch. |
| A4 | Input 4: Status of auxiliary interlock (1 = OK); connect to optional user-defined interlock switch. |
| A5 | Input 5: BEAM ON input (Positive slope). Within the Genius II, this input, when true, switches on the HV and the gun. Connect Pin A5 to a user-determined output from the higher-level controller. For example, if you are using the Genius II in a system equipped with an XTC/3M deposition controller, you can create a circuit similar to that shown in Figure 2-9, which illustrates the use of the XTC/3M's IN LAYER output to provide both the BEAM ON and BEAM OFF inputs. |
| A6 | Input 6: BEAM OFF input (HV OFF = 1). Within the Genius II, this input, when true, switches off the HV and the gun. Connect it to a user-determined output from the higher-level controller. Figure 2-9 shows how this input could be supplied by an XTC/3M deposition controller, using its IN LAYER output. |
| A7 | Output K1: Relay contact with Pin B7; default function = HV ON status (HV ON = 1). |
| A8 | Output K2: Relay contact with Pin B7; default function = Genius II ERROR indicator (ERROR = 1). |
| B1 | Ground reference for Pin A1; jumper to Pin B5. |
| B2 | Ground reference for Pin A2; jumper to Pin B5. |
| B3 | Ground reference for Pin A3; jumper to Pin B5. |
| B4 | Ground reference for Pin A4; jumper to Pin B5. |
| B5 | 0 V reference for Pins A1-A5 |
| B6 | 24 V, 80 mA output; can be used as control voltage for Inputs 1-4. |
| B7 | Relay contact with Pin A7; jumper to Pin B6. |
| B8 | Relay contact with Pin A8; jumper to Pin B6. |

Figure 2-9 Sample Circuit Supplying BEAM ON and BEAM OFF Inputs via X110 Pins 5 and 6

2.4.2 Making Connections to Rear Panel Connector X119

When making connections from rear panel connector X119 and a higher-level controller (i.e., either a deposition controller or a PLC-based system controller), perform the procedure described below.

NOTE

Before performing this procedure, complete the basic cabling procedure described in section 2.3.2.

| Step | Action |
|------|---|
| 1 | Make the connections between the higher-level controller and rear panel connector X110 shown in Figure 2-8. |

- 2 Make connections between the higher-level controller and rear panel connector X119. This can be done in either of two wiring configurations, as shown in Figures 2-10 and 2-11. Table 2-2 provides functional descriptions of the I/Os exchanged via connector X119.

Figure 2-10 Connections to Rear Panel Connector X119, Configuration #1

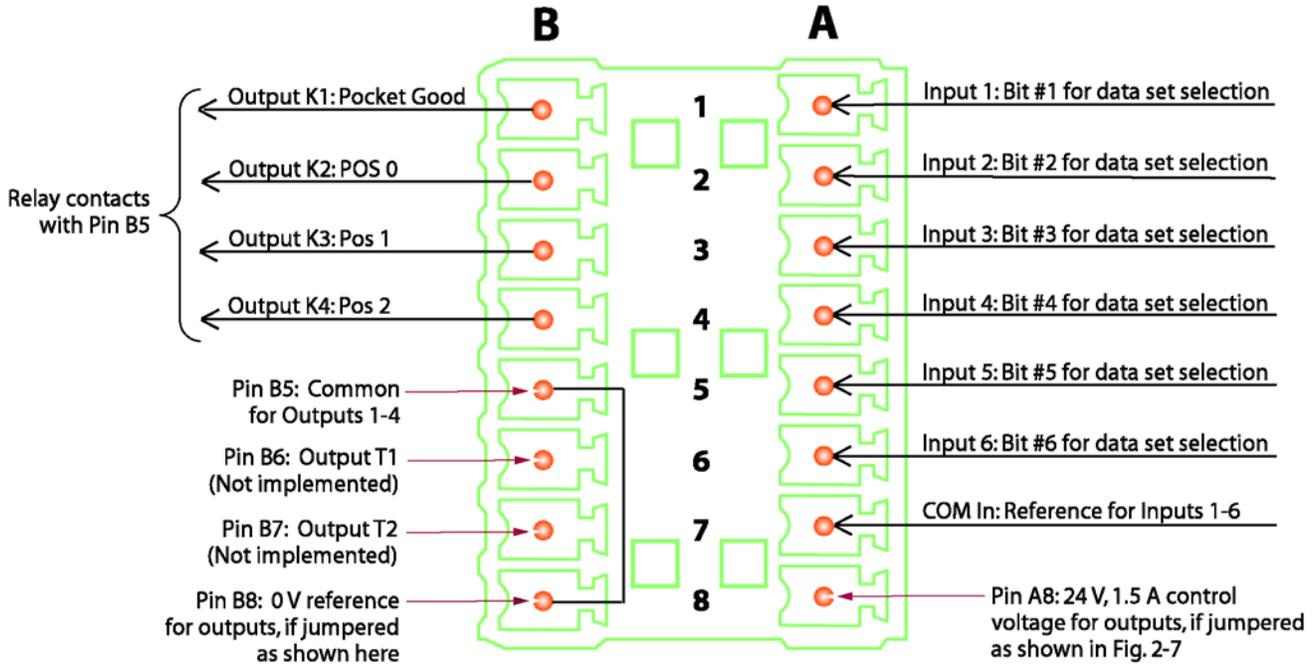

Figure 2-11 Connections to Rear Panel Connector X119, Configuration #2

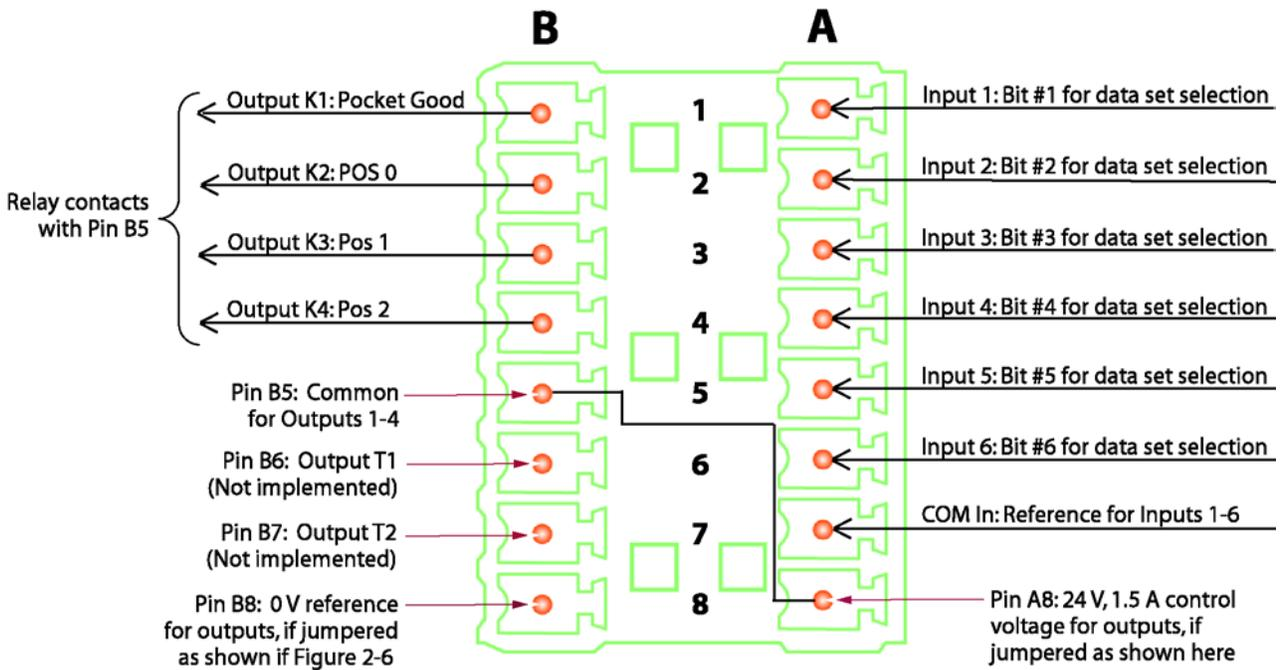

Table 2-2 Functional Descriptions of Pins on Rear Panel Connector X119

| Pin No. | Functional Description |
|---------|---|
| A1 | Input 1: Data-set-selection Bit 1 |
| A2 | Input 2: Data-set-selection Bit 2 |
| A3 | Input 3: Data-set-selection Bit 3 |
| A4 | Input 4: Data-set-selection Bit 4 |
| A5 | Input 5: Data-set-selection Bit 5 |
| A6 | Input 6: Data-set-selection Bit 6 |
| A7 | COM IN; ground reference for inputs 1-6 |
| A8 | 24 V, 1.5 A output; can be connected to Pin B5 to provide control voltage for outputs K1-K4. |
| B1 | Output K1: Relay contact with B5; function = POCKET IN POSITION output. |
| B2 | Output K2: Relay contact with B5; function = POS 0 BCD bit. |
| B3 | Output K3: Relay contact with B5; function = POS 1 BCD bit. |
| B4 | Output K4: Relay contact with B5; function = POS 2 BCD bit. |
| B5 | COM OUT; function = reference for Outputs K1-K4; can be connected to either Pin A8 or Pin B8. |
| B6 | Output T1: Transistorized output not implemented on Genius II |
| B7 | Output T2: Transistorized output not implemented on Genius II |
| B8 | Internally connected to ground; can be connected to Pin B5 to provide 0 V reference for outputs K1-K4 |

2.5 Connecting the AC Power Cable and Powering Up the Genius II

Perform the following procedure to supply AC power to the Genius I.

| Step | Action |
|------|---|
| 1 | Make sure that the rear-panel On/Off switch (see Figure 2-12) is in the Off position. |

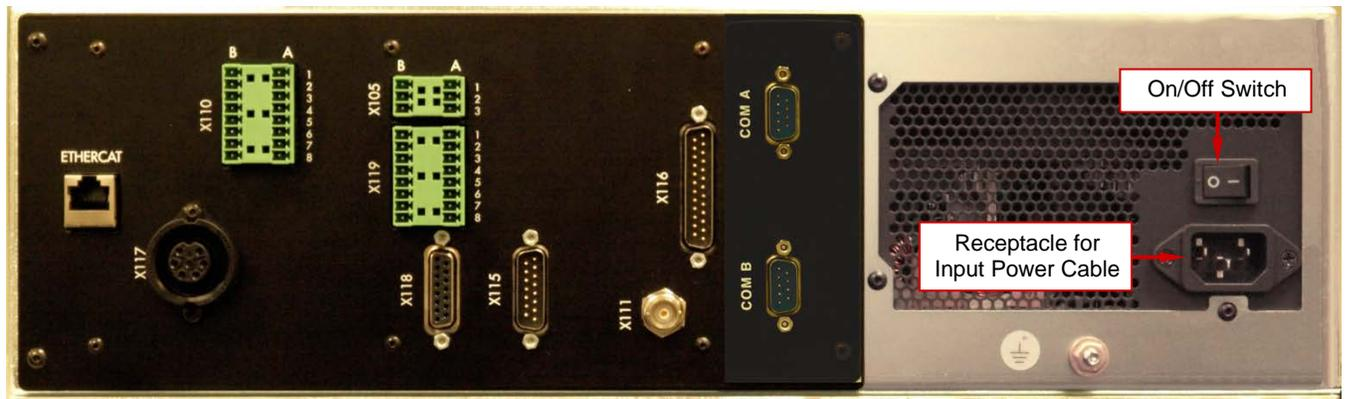
Figure 2-12 Genius II Input Power Cable Receptacle and Rear Panel On/Off Switch

- 2 Plug the unit's power cable into the rear-panel input power receptacle and into an appropriate receptacle supplying AC power.
- 3 Put the rear-panel On/Off switch in the On position.
- 4 Press the front-panel On/Off button (see Figure 2-1). The unit will then display the LogIn screen (see Figure 4-1).

3

Basic Configuration Procedures

3.1 Section Overview

This section describes how to configure the Genius II for operation as a stand-alone controller. For details about configuring a Genius II to operate in conjunction with a deposition controller, see Section 6. For instructions about configuring the Genius II to operate under the control of a PLC-based system controller, see Section 7. Topics covered in this section are:

- Section 3.2 Configuring Control Modules as Local
- Section 3.3 Setting the System Time and Date
- Section 3.4 Configuring the E-Beam Control Module
- Section 3.5 Configuring the Turret Control Module
- Section 3.6 Setting Parameters on the Config>Sweep Screen
- Section 3.7 Configuring Profiles
- Section 3.8 Enabling the LogIn Manager and Changing User Passcodes and Permissions
- Section 3.9 Language Selection
- Section 3.10 Exiting Configuration Mode and Saving Configuration Changes

The procedures described below assume that the Genius II has been correctly installed and cabled up to controlled components and that the unit is powered up.

3.2 Configuring Control Modules as Local

When the Genius II is first booted up, the unit displays the boot-up screen shown in Figure 3-1.

Figure 3-1 Genius II Boot-Up Screen

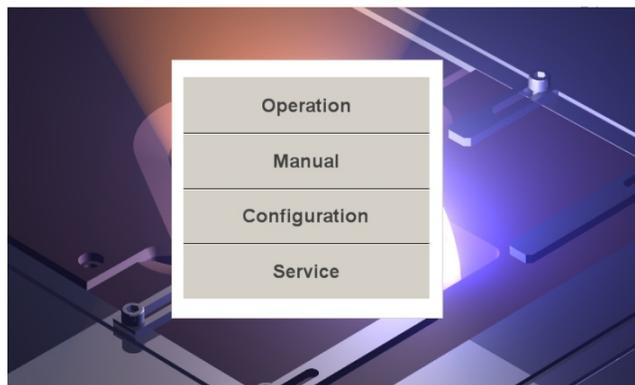

To put the unit into Configuration Mode and configure control modules as **Local**, perform the procedure described below.

- | Step | Action |
|------|---|
| 1 | Touch the splash screen's Configuration button. The unit will then display the Configuration>Main screen (see Figure 3-2). |

Figure 3-2 Config>Main Screen After Initial Boot-Up



- 2 If necessary, change the language to Russian, as described in section 3.9.
- 3 Either leave the E-Beam control module configured as **Offline** or touch its configuration button to select **Local**.
- 4 Do the same for the Sweep and Turret control modules. Figure 3-3 shows how the Configuration>Main screen looks when all control modules are configured as **Local**.

Figure 3-3 Configuration>Main Screen with All Control Modules Configured as Local

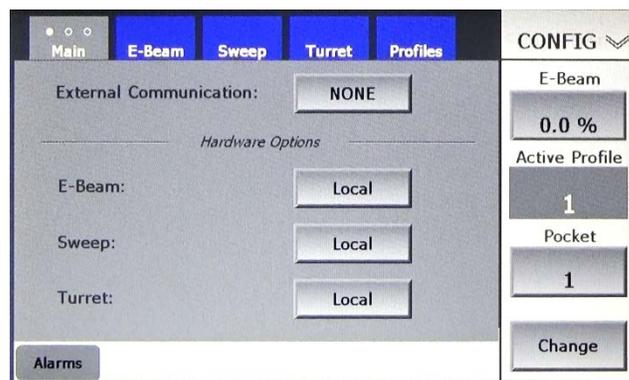

NOTE

The procedures described in sections 3.3 through 3.6 assume that all control modules are configured as **Local**. However, if **Offline** remains selected for a given control module, skip the procedure(s) pertaining to that module.

3.3 Setting the System Time and Date

Perform the following steps to set the system date and time.

- | Step | Action |
|------|--|
| 1 | Touch the Config>Main screen's screen tab twice (see Figure 3-4) to open the System Date/Time screen (see Figure 3-5). |

Figure 3-4 Displaying the System Date/Time Screen

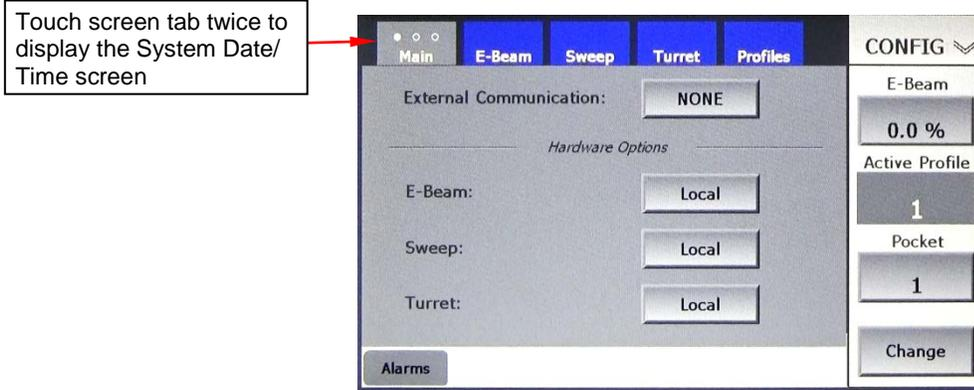
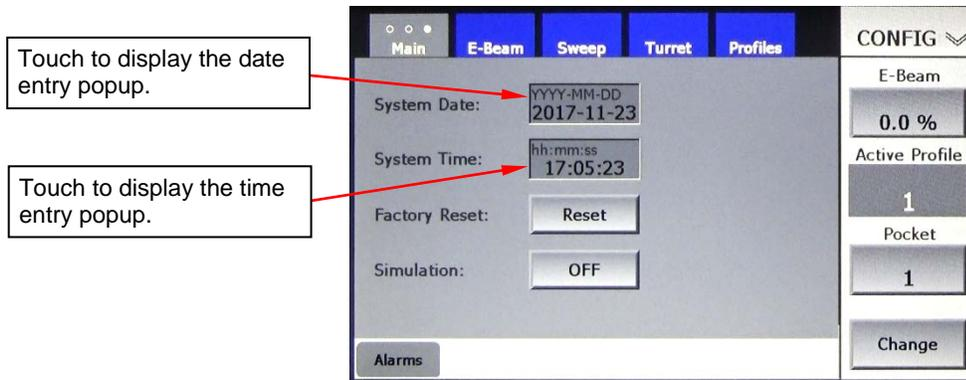
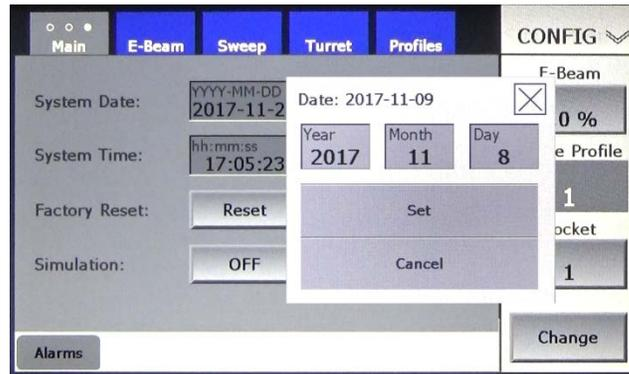

Figure 3-5 System Date/Time Screen



- 2 To change the system date, touch the recessed button bearing the system date to display the popup shown in Figure 3-6.

Figure 3-6 System Date/Time Screen with Date-Entry Popup Displayed



- 3 Touch any of the individual boxes labeled **Year**, **Month**, and **Day** to display a numeric keypad.
- 4 Use this numeric keypad to enter the current year, month, or day, as the case may be.
- 5 Touch the keypad's **Enter** button.
- 6 Repeat Steps 3-5 as necessary to complete the correction of the date. When finished, touch the date-entry popup's **Set** button and then touch the **X** in the popup's upper right-hand corner to close it.
- 7 To change the system time, touch the recessed button bearing the system time to display the popup shown in Figure 3-7.

Figure 3-7 System Date/Time Screen with Time-Entry Popup Displayed

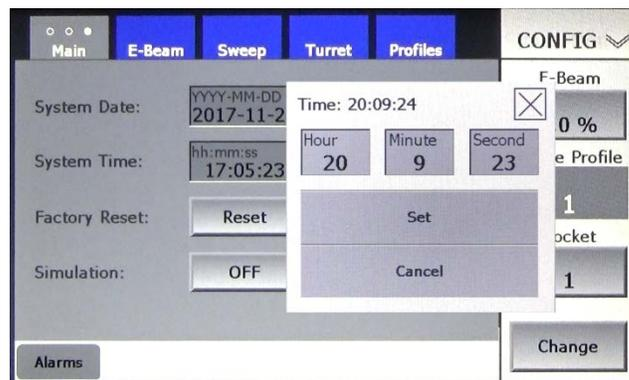

- 8 Touch any of the individual boxes labeled **Hour**, **Minute**, and **Second** to display a numeric keypad.
- 9 Use this numeric keypad to enter the correct number.
- 10 Touch the keypad's **Enter** button.
- 11 Repeat Steps 8-10 as necessary to complete the correction of the date. When finished, touch the time-entry popup's **Set** button and then touch the **X** in the popup's upper right-hand corner to close it.

3.4 Configuring the E-Beam Control Module

To configure the Genius II for your system's high-voltage and filament power supplies, perform the procedures described in sections 3.4.1 and 3.4.2. If desired during these procedures, you can switch on the HV and/or gun by touching the **HV ON** button and/or the **GUN ON** button.

3.4.1 Configuring the Parameters on the Configuration>E-Beam Screen

| Step | Action |
|------|--|
| 1 | Touch the Menu Bar's E-Beam button to display the Configuration>E-Beam screen (see Figure 3-8). |

Figure 3-8 The Configuration E-Beam Screen at Initial Boot-Up

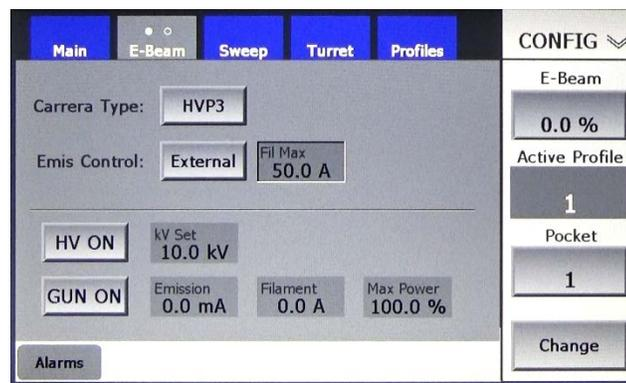

- 2 Select the desired power supply, if it is not already selected. To do so, touch the **Carrera Type** button as many times as necessary to select the appropriate Carrera model.
- 3 If you are installing the Genius II to operate as a stand-alone controller, touch the **Emis Control** button to toggle from **EXTERNAL** to **INTERNAL**. If **INTERNAL** is selected, then the emission power setpoint is determined by user input via the Genius II. If **EXTERNAL** is selected, that setpoint is determined by input from a higher-level controller (i.e., either a deposition controller or a PLC-based system controller).
- 4 If desired, you can also change the value for maximum filament current. To do so:
 - a) Touch the **Fil Max** button to display a numeric keypad.
 - b) Use that keypad to enter the desired bias value.
- 5 Touch **Enter** to close the keypad. The value you entered will then appear on the **Fil Max** button.

Configuration of the parameters relating to the e-beam power supply is now complete. If you have completed all the configuration changes you wish to make at this time, save them, as described in section 3.10. If not, proceed to section 3.4.2.

3.4.2 Tuning the Emission Current's Control-Response Loop

Adjusting Parameters on the Emission Tuning Page

Figure 3-9 shows the Emission Tuning page. To display this page, touch the **E-Beam** screen tab when the Configuration>E-Beam screen is displayed.

Figure 3-9 The Emission Tuning Page at Initial Boot-Up

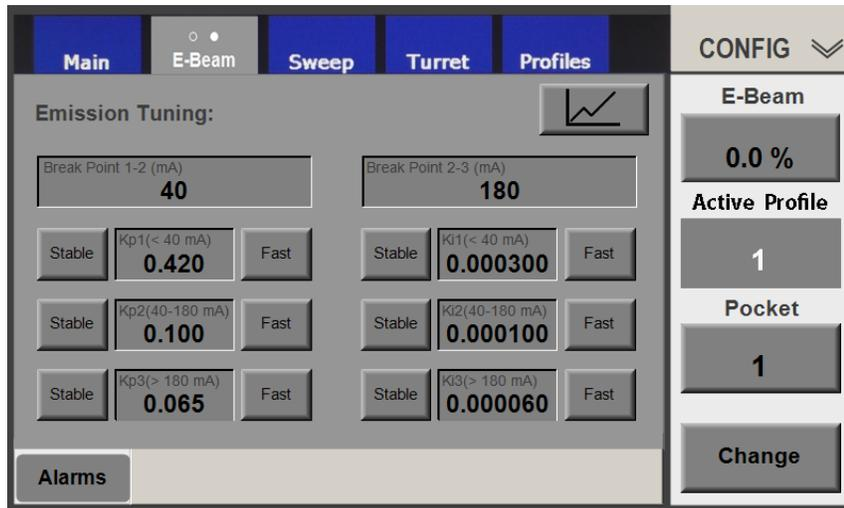

This screen enables you to tune the emission current's response curve by adjusting a number of parameters which define that curve. For tuning purposes, the response curve is broken up into three segments. The entry box labeled **Break Point 1-2** (see Figure 3-10) allows you to adjust the break point between the lower and middle segments of the curve. The entry box labeled **Break Point 2-3** allows you to adjust the break point between its middle and upper segments.

Figure 3-10 Emission Tuning Page with Entry Boxes for Break Point Outlined

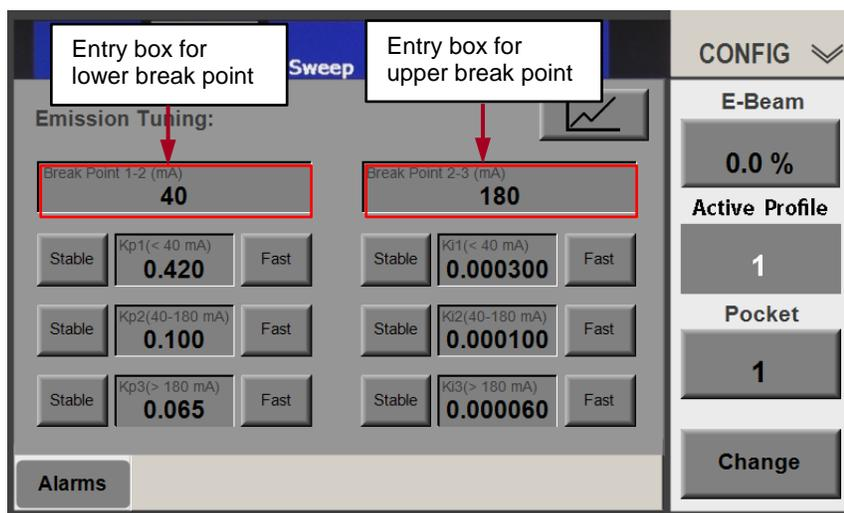

To change the setpoint value for a given break point, perform the following procedure:

- | Step | Action |
|------|--|
| 1 | Touch the entry box for the break point whose value you wish to change. |
| 2 | Use the numeric keypad that will then appear to enter the new setpoint value. |
| 3 | Touch the keypad's Enter button to close it. The new value will then appear in the center of the entry box. |

In addition, you can adjust the Proportional and Integral terms of the correction function applied to the control loop. The left-hand column of value-display windows and buttons (see Figure 3-11) enables you to adjust the Proportional term of the control function for segments 1, 2, and 3 of the response curve. The right-hand column (see Figure 3-12) enables you to adjust the Integral term for those segments.

To increase the value of a given setpoint, touch the **Fast** button next to the value-display box for that setpoint. To decrease that setpoint's value, touch the **Stable** button next to the same value-display box.

Figure 3-11 Emission Tuning Page with Value Display Boxes and Adjustment Buttons for Proportional Term Outlined

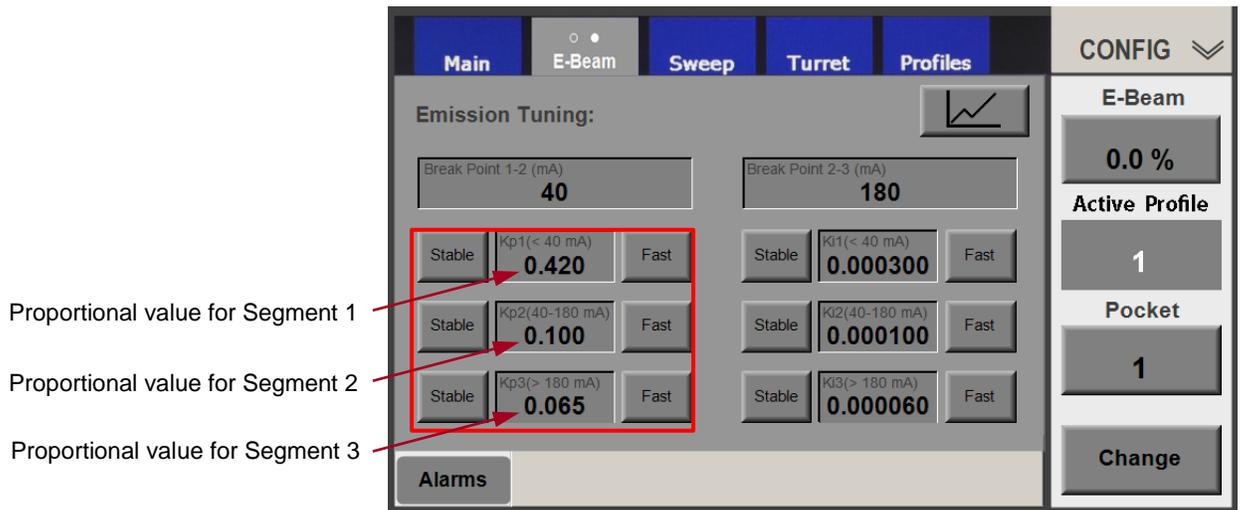
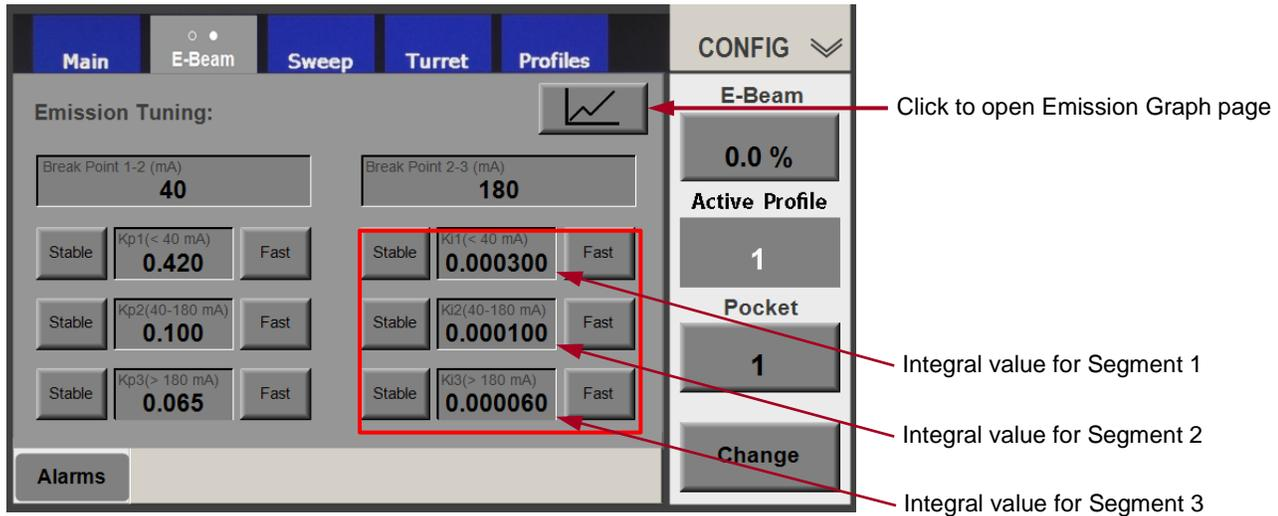

Figure 3-12 Emission Tuning Page with Value Display Boxes and Adjustment Buttons for Integral Term Outlined



Using the Emission Graph Page to Monitor the Response Loop in Real Time

The Emission Graph page (see Figure 3-13) allows you to view the emission response curve in real time. To open this page, click the button indicated in Figure 3-12. As Figure 3-13 shows, the high-voltage value is traced in red, the emission current setpoint in green, and the actual emission current in blue.

To initiate emission current tracing in real time, touch the button indicated in Figure 3-13. The Emission Graph page will then appear as shown in Figure 3-14. On that page, the HV value and the emission setpoint are shown as horizontal lines that are red and green, respectively, and the actual emission current value is shown as a blue trace.

Figure 3-13 The Emission Graph Page When Emission Current Tracing Is Inactive

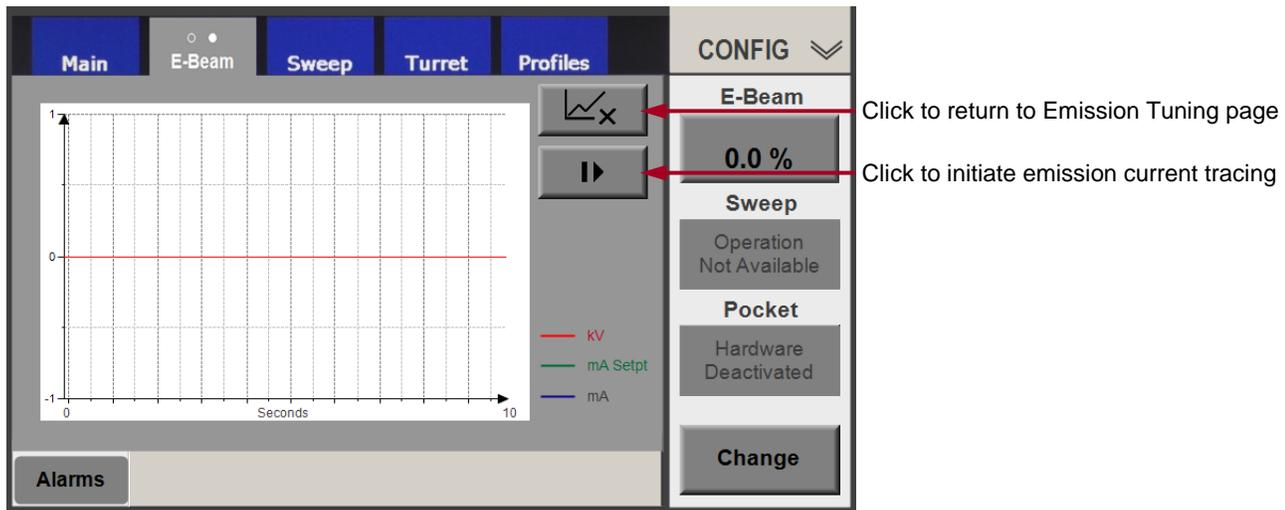
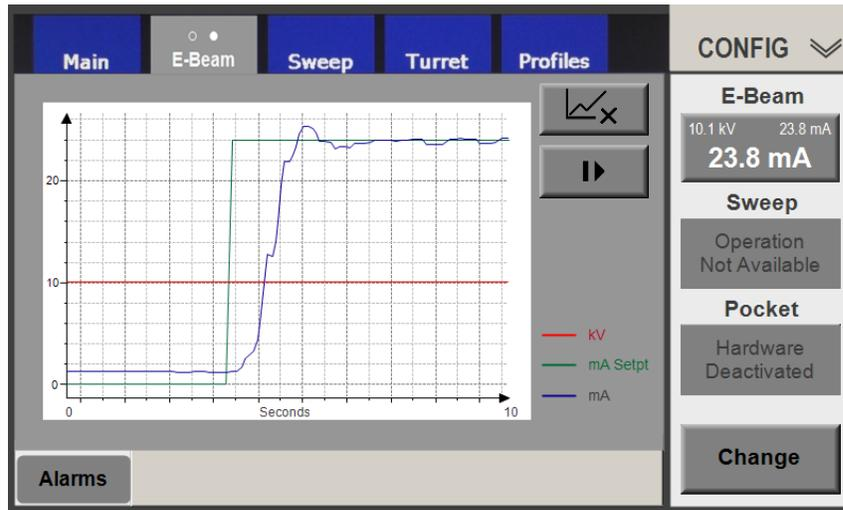

Figure 3-14 The Emission Graph Page When Emission Current Tracing Is Active



If you have made all the configuration changes you wish to make at this time, save your changes and exit from Configuration mode, as described in section 3.10. Otherwise, proceed to section 3.5.

3.5 Configuring the Turret Control Module

3.5.1 Configuring the Turret Control Module for More Than One Pocket

Overview of the Config>Turret Screen

Figure 3-15 shows the Configuration>Turret screen as it appears when the Turret control module is configured for a source with more than one pocket. In this state, the features on the Config>Turret screen enable you to configure the following parameters:

- Pocket Motion, either clockwise (**CW**), counterclockwise (**CCW**), or **Linear**
- Number of pockets (4-12)
- Seek Speed, as a percentage of maximum motor speed
- Index Speed, also as a percentage of maximum motor speed.

Seek Speed is the speed at which the turret rotates when it is seeking Pocket 1 after the turret motor is activated. Index Speed is the speed at which the turret rotates during normal pocket-to-pocket rotation.

NOTE

The drive motor's rotation speed is four times that of the turret.

Figure 3-15 Config>Turret Screen at Initial Boot-Up

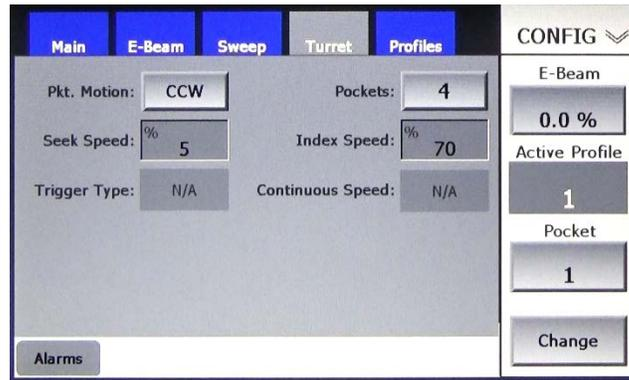

Setting the Turret Drive Parameters

Perform the following procedure to set the turret drive parameters.

- | Step | Action |
|------|--|
| 1 | First select the desired form of pocket motion. If the default (CCW) is appropriate, skip this step and proceed to Step 2. To change the rotation direction, touch the Rotation button to toggle either to CW or Linear . |
| 2 | Next select the number of pockets. To do so, touch the Pockets button repeatedly until the correct number is displayed on that button. |
| 3 | Set the Seek Speed. If the default seek speed value (5 %) is acceptable, skip this step and proceed to Step 4. To change the Seek Speed value: <ol style="list-style-type: none"> Touch the Seek Speed button to display a keypad popup Use that popup to enter the desired value. Touch the keypad's Enter button to close it. The value you entered will then appear on the Seek Speed button. |
| 4 | Select the Index Speed. If the default value (70%) is acceptable, skip this step. If not: <ol style="list-style-type: none"> Touch the Index Speed button to display a keypad popup Use that popup to enter the desired value. Touch the keypad's Enter button to close it. The value you entered will then appear on the Index Speed button. |

3.5.2 Setting Turret Control Parameters for a Continuous Rotation Turret

The Genius II makes it possible to configure the turret-control module for use with a continuous-rotation material holder. To do so, start by selecting **1** opposite **Pockets** on the Config>Turret screen. That

screen will then display the set of parameters shown in Figure 3-16. Then perform the procedure described below.

NOTE

The Config>Turret screen appears as shown in Figure 3-16 when the turret control module is configured as **Local**. When that module is configured as **Remote I/O**, the Config>Turret screen appears as shown in Figure 3-19, making the **Trigger Type** parameter available.

Figure 3-16 Config>Turret Screen when Number of Pockets is 1

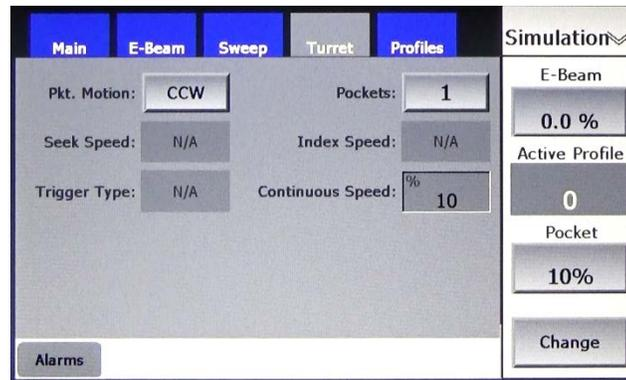

Step Action

- 1 If desired, touch the **Pkt. Motion** button to toggle the rotation setting to **CW**. Do not select **Linear**.
- 2 To adjust the continuous-rotation speed, touch the recessed **Continuous Speed** button. The system will then display the numeric keypad shown in Figure 3-17.

Figure 3-17 Config>Turret Screen Displaying Keypad for Entry of Continuous Rotation Speed

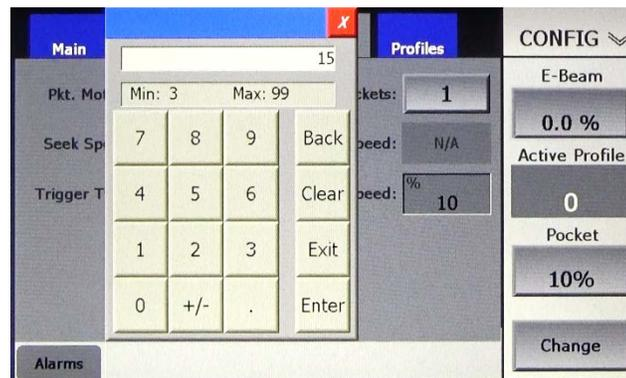

- 3 Using this keypad, enter the desired rotation speed, as a percentage of your turret gun's maximum rotation speed. In the example shown above, the user has entered **15**.

- 4 Touch the keypad's **Enter** button to close it. The value you entered will then appear on the **Continuous Rotation** button, as shown in Figure 3-18.

Figure 3-18 Config>Turret Screen After User Enters 15% for Continuous Rotation Speed

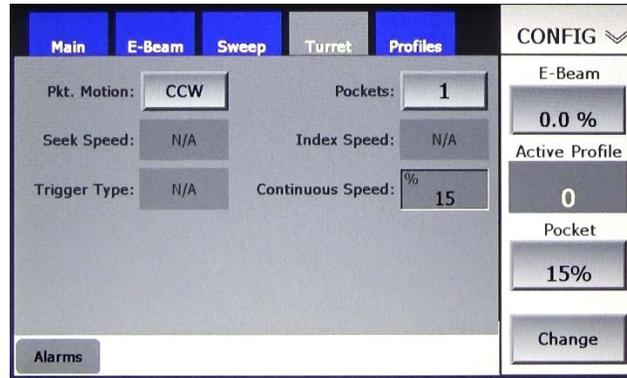

- 5 If turret rotation in your system is controlled by a higher-level controller, the turret control module will be configured as **Remote I/O**. In that case, the Config>Turret screen will display the **Trigger Type** button shown in Figure 3-19. Touch that button to toggle between **HV** and the default, **Emis**. If you select **HV**, continuous rotation begins when the high-voltage is switched on. If you select **Emis**, rotation begins when nonzero emission current is detected.

Figure 3-19 Config>Turret Screen when Turret Control Module Is Configured as *Remote I/O*

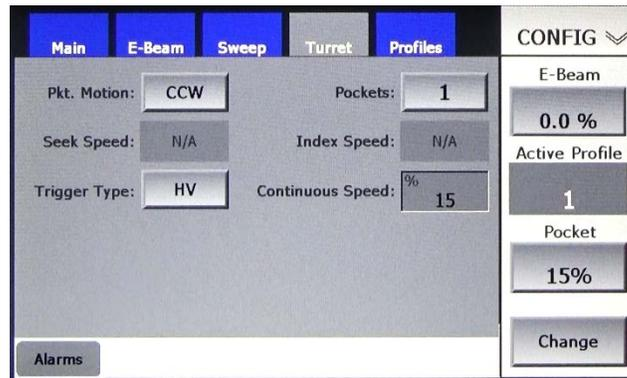

The basic turret configuration procedure is now completed. For instructions on assigning material names to specific pockets, see section 3.7.2. If you have made all the configuration change you wish to make at this time, save your changes, as described in section 3.10. If not, proceed to section 3.6.

3.6 Setting Parameters on the Config>Sweep Screen

Figure 3-20 shows the Config>Sweep screen. To display this screen, touch the main menu's **Sweep** button. The parameters on the Config>Sweep screen are described in detail below the illustration.

Figure 3-20 Config>Sweep Screen in its Initial State

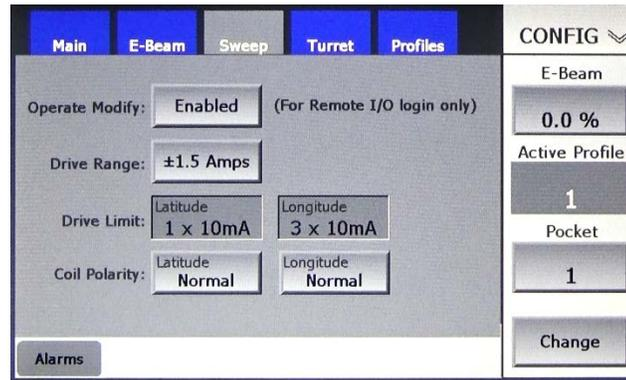

Operate Modify button: Use this button to toggle between **Enabled** and **Disabled**. If the sweep control module is configured as **Local**, touch this button to select **Disabled**. The Config>Screen will then appear as shown in Figure 3-21.

Figure 3-21 Config>Sweep Screen After User Selects Disabled for Operate Modify

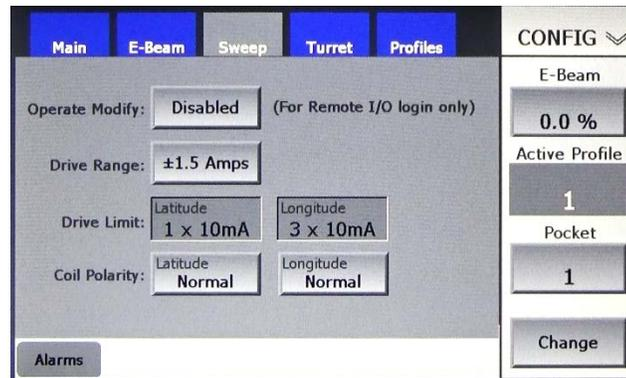

When the Sweep control module is configured as **Remote I/O** and the Log-In manager is enabled, selecting **Enabled** prevents users who have only Operations mode access from changing sweep programs. Under these conditions, all other users can modify sweep programs when the Genius II is in either Operations mode or Manual mode. Note also the following:

- When the Log-In Manager is disabled, all users can modify sweep programs when the Genius II is in either Operations or Manual mode, even if the sweep control module is configured as **Remote I/O** and **Enabled** is selected for **Operate Modify**.
- Selecting **Enabled** has no effect when the Sweep Control module is configured as **Local**. In that case, all users are allowed to modify sweep programs whenever the Genius II is in either Operations or Manual mode.

Drive Range button: Pressing this button allows the user to increase the maximum current output of the longitudinal and lateral beam-position coils to a value higher than the default (± 1.5 A). The available selections are ± 1.5 A, ± 2.0 A, ± 2.5 A, and ± 3.0 A. When the Genius II is in Configuration mode with the beam limits disabled, the **Drive Range** function can be used to limit beam travel in both axes, thus

protecting the uncooled portions of the e-gun. Limiting the coils' drive range can also reduce the likelihood of coil overheating when the beam limits are disabled. Note that increasing the **Drive Range** value decreases the size of the bounding box on Profiles page 1 (see Figure 3-22). Note also that the **Drive Range** value affects the operation of the Sweep control module only when the Genius II is in Configuration mode.

Figure 3-22 Change in Size of Bounding Box Depending on the *Drive Range* Value

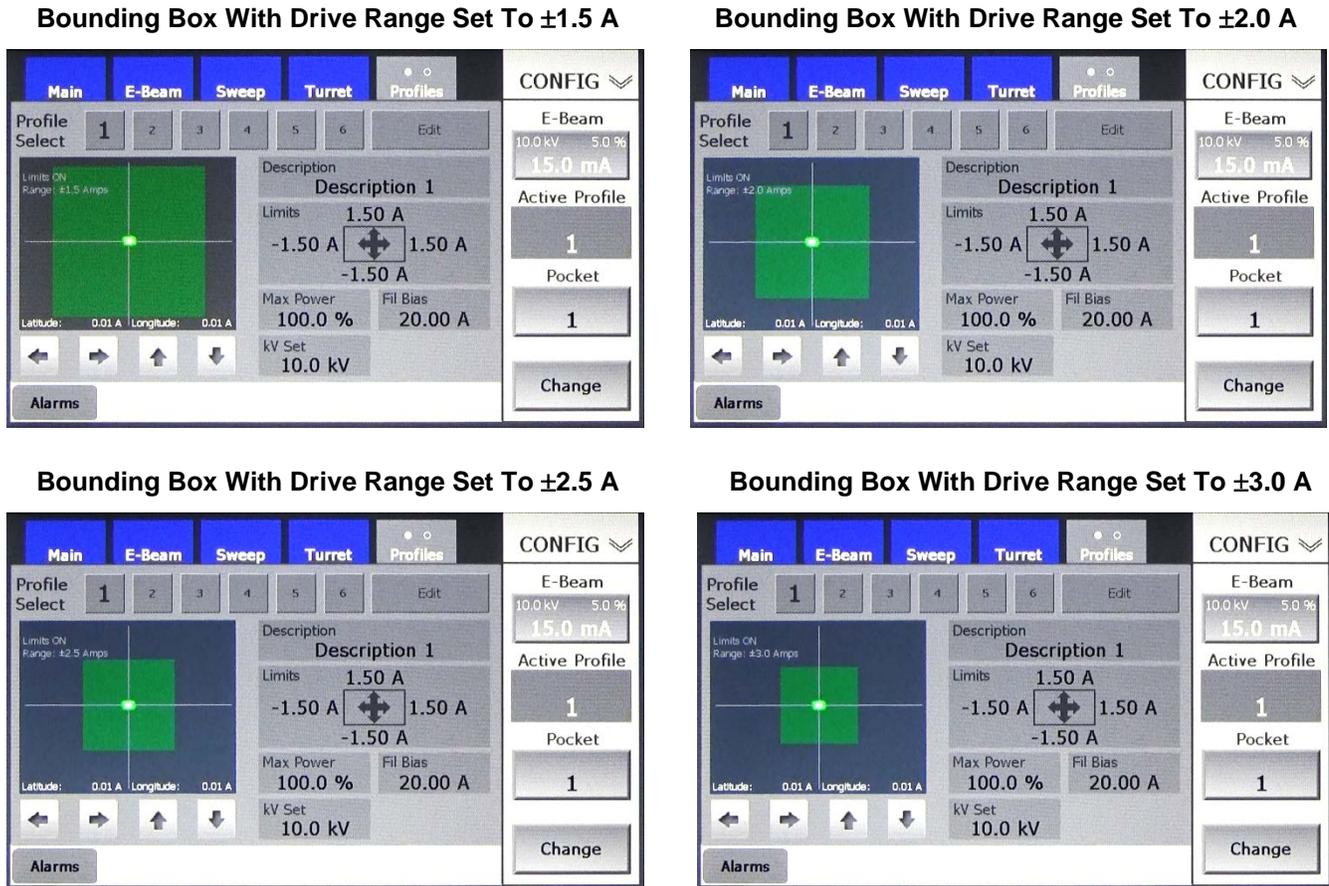

Drive Limit button: Press this button to display a numeric keypad that allows you to change the **Drive Limit** value. That value

- determines the thickness of a buffer zone within the bounding box defined by the beam position interlock limits.
- affects Genius II operations only in Operations and Manual modes.

Note that the actual Drive Limit value is 10 times the number entered in the **Drive Limit** entry box, so that with an entered **Drive Limit** value of 20 creates a buffer 200 mA wide within the bounding box. In Figure 3-23, the green dashed lines mark out this buffer zone, while the red rectangle shows its inner boundaries.

Figure 3-23 Buffer Zone Defined by the Drive Limit Value

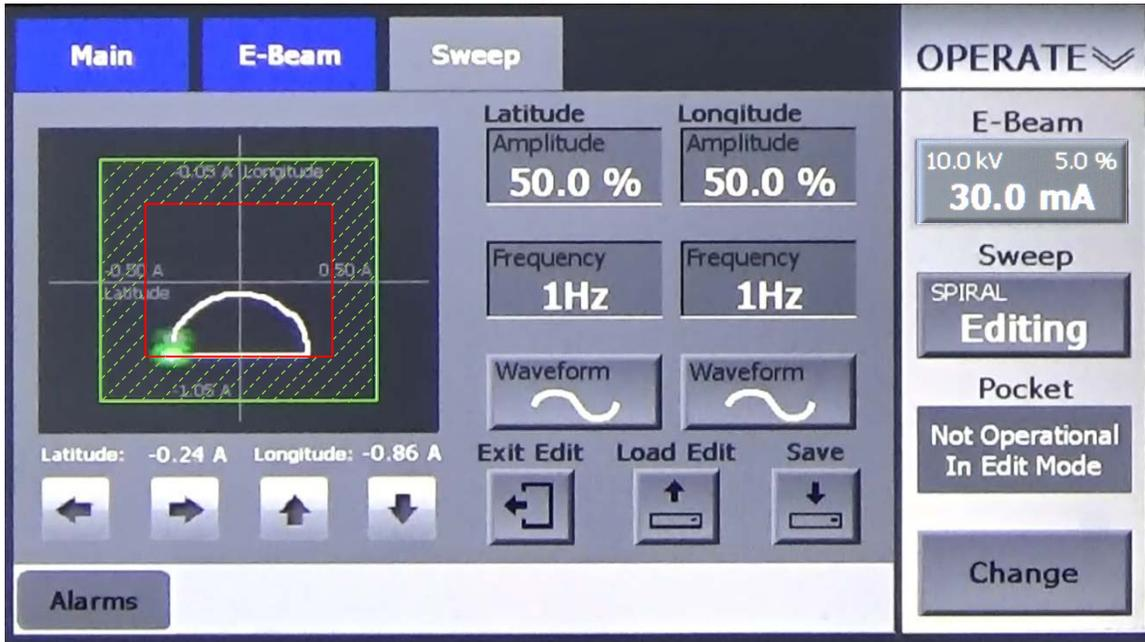

When a beam sweep pattern meets this buffer zone, it is clipped along its outer edge and travels along that edge until it reaches the point at which the sweep pattern would direct the beam back inside the area bordered by the buffer zone. Figure 3-24 shows this clipping effect in two cases, one in which the **Drive Limit** value is set to 5 (= a buffer that is 50 mA wide) and the other in which that value equals 20 (= a 200 mA-wide buffer). In both examples, the clipped sweep pattern is a circle.

Figure 3-24 ‘Clipping’ of Beam Sweep Pattern Depending on the *Drive Limit* Value

Drive Limit Value Set To ± 50 mA in both Axes

Drive Limit Value Set To ± 200 mA in both Axes

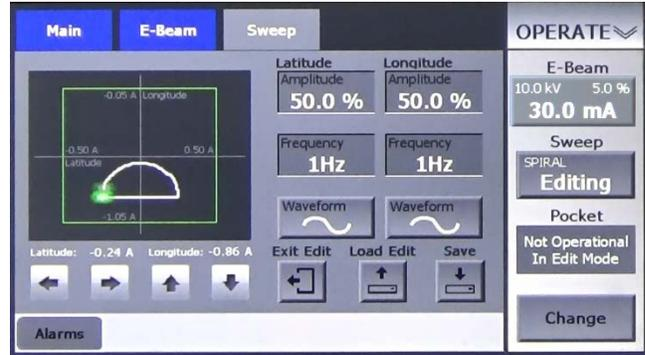
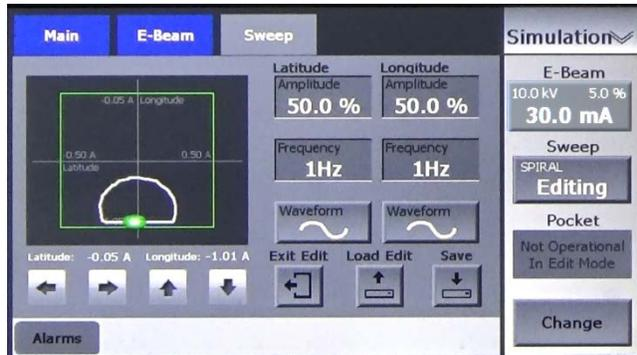

Due to this clipping effect, the **Drive Limit** value can be used to prevent the beam from being switched off in cases in which it would otherwise travel outside the user-set beam limits.

Coil Polarity buttons: These buttons enable the user to toggle between normal and reverse polarity for the gun's latitudinal and longitudinal beam position coils. Doing so is useful in cases where the coil current leads have been connected backwards or in cases where the user wishes to reverse coil polarity for some other reason. Note that the coil polarity selections affect beam-motion control in all Genius II operating modes.

If you have made all the configuration changes you wish to make at this time, exit from Configuration mode and save your changes, as described in section 3.10. Otherwise, proceed to section 3.7.

3.7 Configuring Profiles

Profiles Pages 1 and 2 (see Figure 3-25) enable the user to

- create up to six profiles consisting of suites of power supply and beam limit parameters and
- apply any of these profiles to one or more of a turret gun's pockets.

Figure 3-25 Profiles Pages 1 and 2

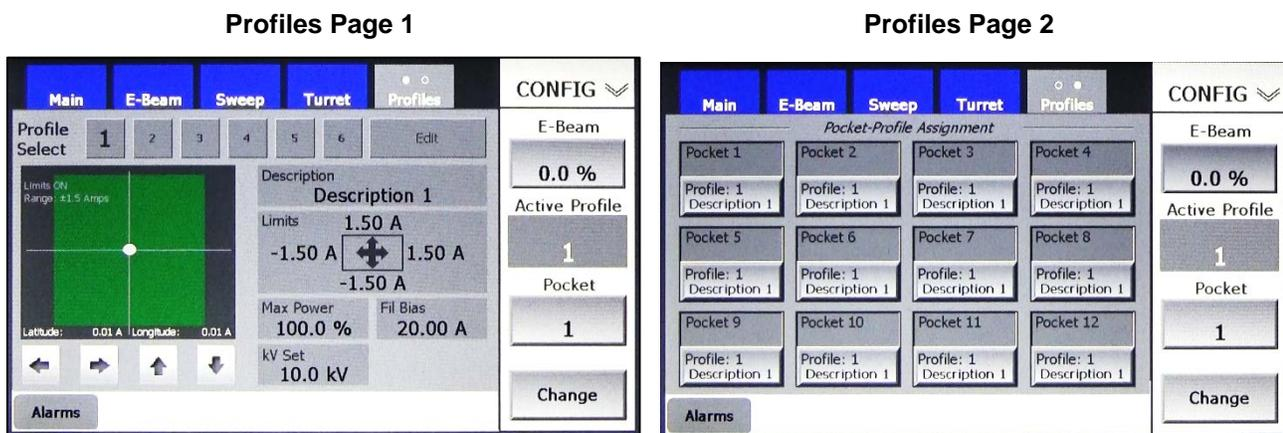

Profile configuration entails two separate procedures. In Procedure 1, the user determines the number of profiles to be configured and assigns profiles to pockets. Optionally, the user can also assign a material name or other descriptive character string to each pocket. These operations are described in detail in sections 3.7.1 and 3.7.2.

In Procedure 2, the user assigns specific power supply parameters and beam position interlock limits to each of the profiles that are to be configured. A descriptive word or title can also be assigned to each profile. These operations are covered in sections 3.7.3, 3.7.4, and 3.7.5.

3.7.1 Associating Profiles to Pockets

Profiles Page 2 enables the assignment of profiles to pockets. As shown in Figure 3-26, Profile 1 is initially assigned by default to all available pockets. To change a pocket's profile assignment, touch the button labeled **Profile: 1** below the target pocket's number as many times as required to display the number of the profile you wish to assign to that pocket. Figure 3-27 shows Profiles Page 2 after the user has changed the profile assignments of Pockets 2-5 and 7-12.

Figure 3-26 Profiles Page 2 at Initial Boot-Up

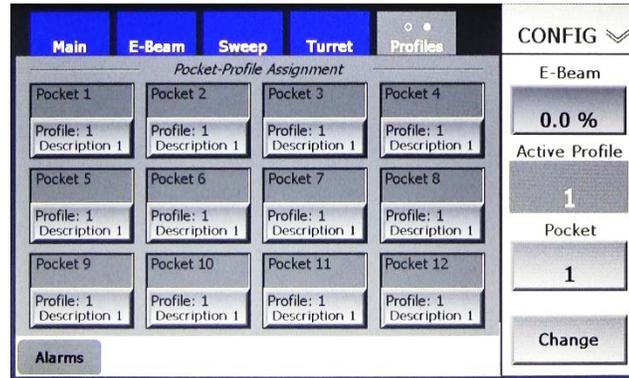
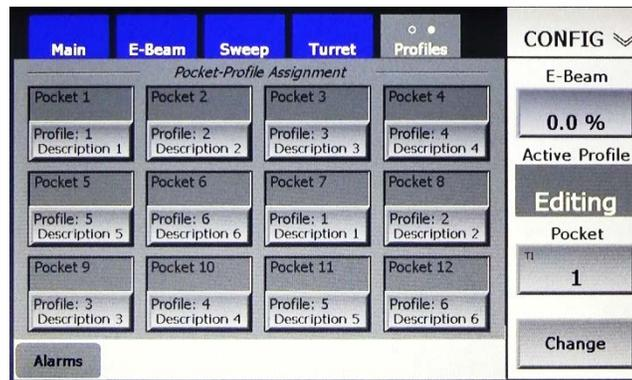

Figure 3-27 Profiles Page 2 After Pocket-Profile Assignments Are Changed

**NOTE**

In Figure 3-27 Profiles 1-6 are assigned in numerical order to pockets 1-6 and again in order to pockets 7-12. However, any profile can be assigned to multiple pockets, and Profiles do not have to be assigned to pockets in any particular order.

3.7.2 Associating Material Names with Pockets (Optional)

Perform the procedure described below to assign material names or other descriptive text strings to specific pockets.

- | Step | Action |
|------|---|
| 1 | Display Profiles Page 2, if it is not already displayed. |
| 2 | To enter a material name for Pocket 1, touch the recessed Pocket 1 button on this page to open an on-screen alphanumeric keyboard. |
| 3 | Use this keyboard to enter the desired material name or abbreviation. In Figure 3-28, the user has entered TI . |

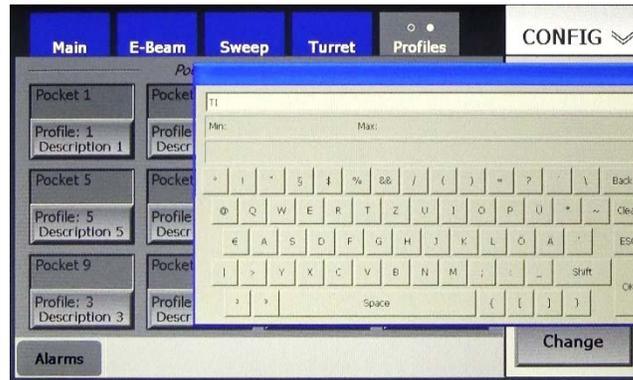
Figure 3-28 Keyboard After User Enters *T1*

- 4 Touch the keyboard's **OK** button to close it. The name you entered now appears on the **Pocket 1** button, as shown in Figure 3-29.

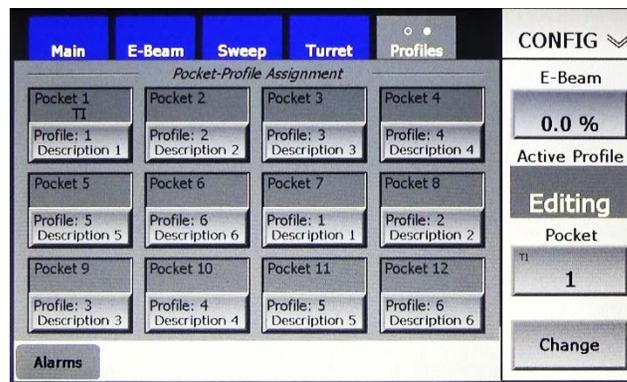
Figure 3-29 Profiles Page 2 After User Enters *T1* for Pocket 1

- 5 Repeat Steps 2-4 as desired to assign material names to other pockets.

3.7.3 Overview of Profiles Page 1

Profiles Page 1 (see Figure 3-30) enables the user to configure up to six profiles, each of which can be associated with one or more pockets in a multipocket source. For each such profile, Profiles page 1 allows the user to:

- set limits for the beam position interlocks for the profile currently selected
- set a Max. Power value for that profile
- determine the voltage at which the HV will operate for that profile
- determine the filament bias current for that profile

These parameter values will be applied to any pocket to which the profile in question is assigned. Profiles Page 1 also enables the user to apply a descriptive title or other text string to each profile.

Figure 3-30 Profiles Page 1, in its Initial State



Touching this screen’s **Edit** button displays it in Editing Mode A (see Figure 3-31). Editing Mode A permits adjustment of the **Max. Power**, **Fil Bias**, and **KV Set** values and the entry of descriptive text in the **Description** field. Editing Mode B (see Figure 3-32) enables adjustment of beam position interlock limits. To toggle between these two editing modes, touch the button in the center of the area where the beam position limit values are displayed in Mode A and where the Set Beam Position Limit buttons are displayed in Mode B.

Figure 3-31 Profiles Page 1 In Editing Mode A

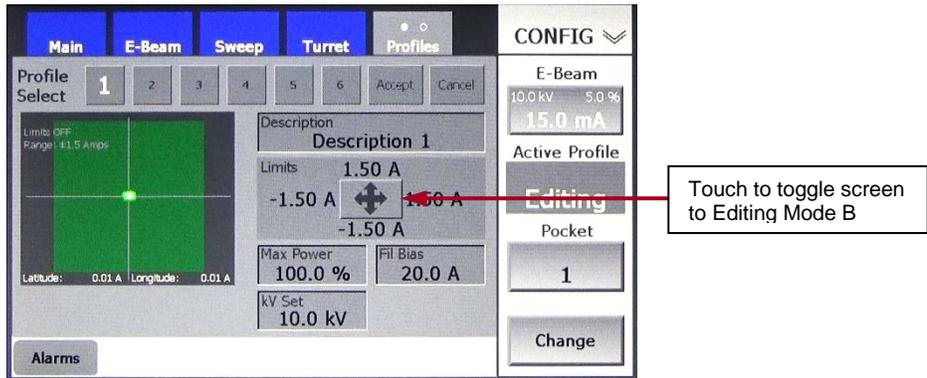
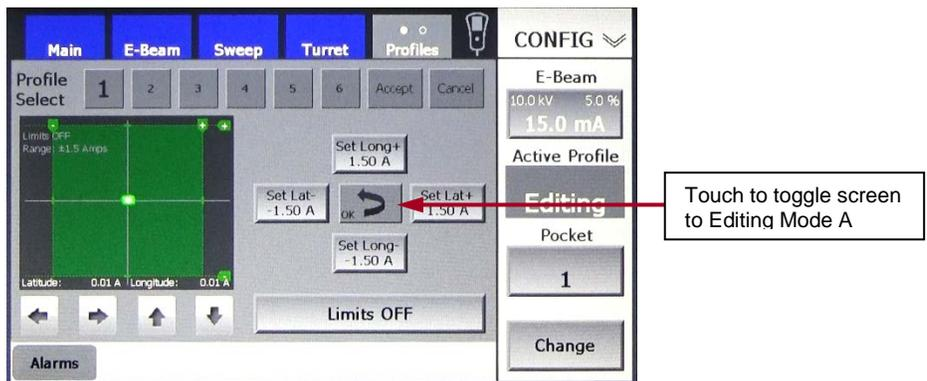

Figure 3-32 Profiles Page 1 In Editing Mode B



3.7.4 Setting Parameters in Editing Mode A

When Profiles Page 1 is in Editing Mode A, perform the following procedure to adjust **Max. Power**, **Fil Bias**, and **KV Set** values.

| Step | Action |
|------|--|
| 1 | Touch the recessed entry button for the parameter whose value you wish to adjust. |
| 2 | The system will then display a numeric keypad. Use that keypad to enter the desired value. |
| 3 | Touch the keypad's Enter button to close it. The new value will then appear in the recessed button you touched in Step 1. |

To enter descriptive text in the recessed **Description** button, touch that button and use the keyboard that will then appear to enter the desired text. When finished, touch the keyboard's **OK** button to close it. The text you entered will then appear in the **Description** button.

3.7.5 Setting Beam Position Interlock Limits

Profile Page 1 Features Used in Setting Beam Position Interlock Limits

Figure 3-33 shows Profiles Page 1 in Editing Mode B and identifies the features of that screen which are used to adjust beam position limits.

Figure 3-33 Features Displayed on Profiles Page 1 when in Editing Mode B

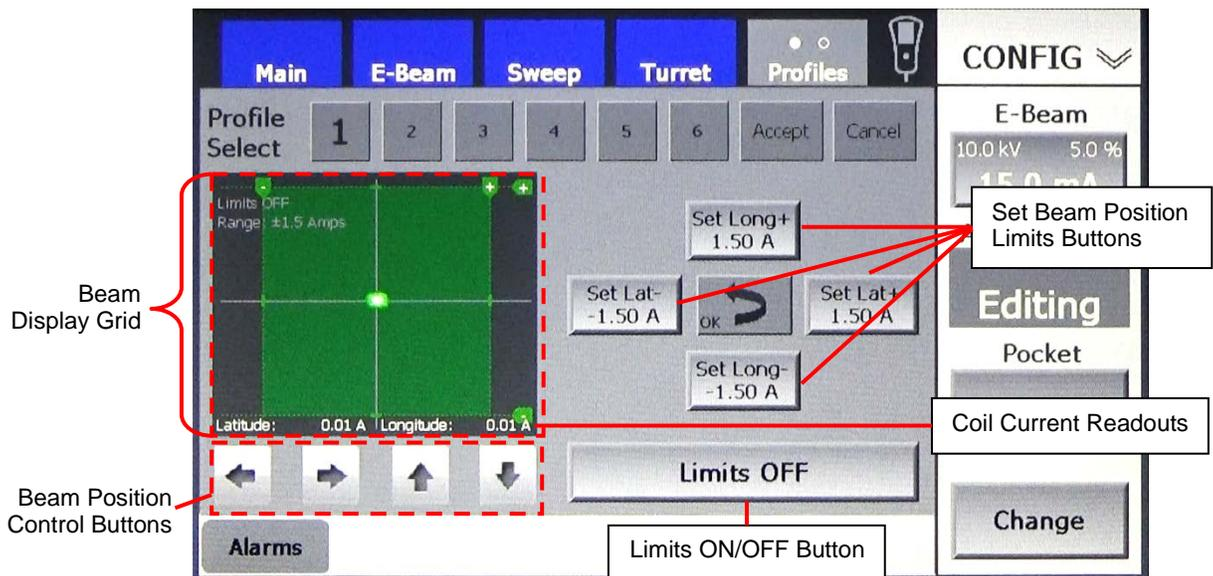

Those features are:

- **Beam display grid:** Displays the beam's current position.
- **Coil current readouts:** Indicate the coil current outputs at the beam's current position.

- **Beam position control buttons:** Enable the user to move the beam up/down right/left.
- **Set Beam Position Limit buttons:** Pressing one of these buttons sets that beam position interlock limit at the beam's current position.
- **Limits ON/OFF button:** Enables the user to enable/disable the beam position interlock limits.

NOTE

When the beam is switched on, the screen's beam spot appears as shown above only when the active profile is selected. When any other profile is selected, the beam's position will be accurately shown, but it will be represented as an inactive beam spot.

Effect of Enabling/Disabling Limits

Beam Limits ON: Under these conditions, if the user attempts to drive the beam beyond any of the four beam position limits, the following events occur:

- The beam limit bounding box turns red.
- The beam is switched off.
- The Genius II issues a beam-position alarm, which must be acknowledged and cleared before the beam can be switched back on.

In order to resume the configuration procedure with the beam on, the user must then acknowledge the beam position alarm, move the beam spot back inside the bounding box, select the desired beam power level, and switch the beam back on.

Beam Limits OFF: If the user drives the beam beyond any of the four beam position limits, the Genius II does not issue a beam position error, so the beam remains on.

CAUTION

When beam limits are disabled and the Genius II is in Configuration Mode, it is possible to drive the beam onto the uncooled copper surface of the e-gun, potentially damaging it. Under these conditions, it is critical to set a **Drive Range** value (see section 3.6) that protects the gun.

Setting the Beam Position Interlock Limits

| Step | Action |
|------|---|
| 1 | First display the Config>Sweep screen (see Figure 3-20) and, if necessary, change the Drive Range value. Set a value that ensures that the gun is protected while the beam position interlock limits are disabled. |
| 2 | Open the shutter so that the pocket in evaporation position is visible through the viewport. |
| 3 | Display Profiles Page 1 and touch its Edit button. Then touch the Mode A/Mode B toggle button to display the page in Editing Mode B. |
| 4 | Switch on the beam at a power level at which the beam is just visible through the viewport. Figure 3-34 shows Profiles Page 1 in Editing Mode B and with the beam on at 5% (15 mA). |

Figure 3-34 Profiles Page 1 in Editing Mode B, Beam Switched On



- 5 Watching the beam through the viewport, push the hand-held controller's joystick to the right and check to see whether the beam moves to the right. If it moves to the left, display the Config>Sweep screen and touch the **Latitude Normal** button to toggle it to **Latitude Reverse**.
- 6 Now push the hand-held controller's joystick upward. The beam should then move away from the emitter. If it moves in toward the emitter, touch the **Longitude Normal** button to toggle it to **Longitude Reverse**.

NOTE

The coil-polarity selection affects beam-motion control in all Genius II operating modes.

- 7 When you have finished checking the direction of beam motion, leave the beam on at the same low power level.
- 8 Return to Profiles Page 1, press its **Edit** button, display the screen in Editing Mode B, and make sure that the beam is still on at a low power level.
- 9 Pick up the hand-held remote controller and, if its Menu 2 is not selected, press the remote controller's **Menu** button. Its screen will then appear as shown in Figure 3-35.

Figure 3-35 Remote Controller in Config Mode, Beam On at 5%, Menu 2 Displayed

- 10 Watching the beam through the viewport, use the remote controller's joystick button to move the beam to the desired position for the negative latitudinal beam position limit. This is the point at which the beam's outer edge just touches the left-hand edge of the evaporant pool, as illustrated in Figure 3-36.

Figure 3-36 Beam at Correct Position for Negative Latitudinal Limit

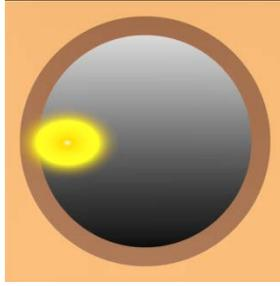

- 11 Press the remote controller's **Set -Lat** button to set the -Latitude position limit at this point. The remote controller's screen will then appear as shown in Figure 3-37, with a white dashed line indicating the limit you have just set.

Figure 3-37 Remote Controller Screen After User Sets the -Lat Beam Position Interlock Limit



- 12 Use the joystick to move the beam to the position desired for the positive latitudinal limit. This is the point at which the beam's outer edge touches the right-hand edge of the evaporant pool (see Figure 3-38).

Figure 3-38 Beam at Correct Position for Positive Latitudinal Limit

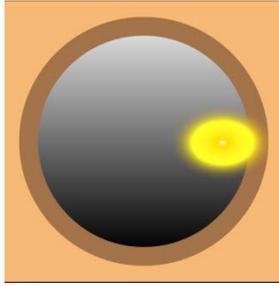

- 13 Press the remote controller's **Set +Lat** button. Its screen will then appear as shown in Figure 3-39.

Figure 3-39 Remote Controller Screen After User Sets +Lat Beam Position Interlock Limit



- 14 Use the joystick to re-center the beam. Then move the beam to the correct point for the negative longitudinal limit. This is the point at which the beam's lower edge touches the edge of the evaporant pool nearest to the emitter (see Figure 3-40).

Figure 3-40 Beam at Correct Position for Negative Longitudinal Beam Limit

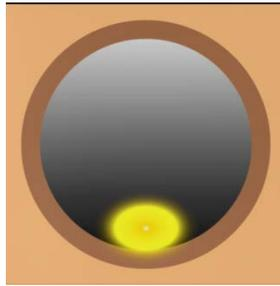

- 15 Press the remote controller's **Set -Long** button. Its screen will then appear as shown in Figure 3-41.

Figure 3-41 Remote Controller Screen After User Sets -Long Beam Position Interlock Limit

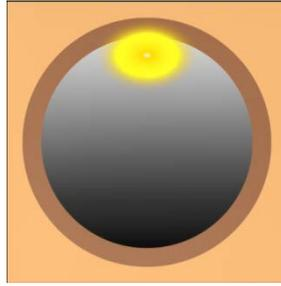

- 16 Finally, move the beam to the correct point for the positive longitudinal limit. This is the point at which the beam's upper edge touches the edge of the evaporant pool farthest from the emitter (see Figure 3-42).

Figure 3-42 Beam at Correct Position for Positive Longitudinal Beam Limit

- 17 Press the remote controller's **Set +Long** button. Its screen will then appear as shown in Figure 3-43, and Profiles Page 1 will appear as shown in Figure 3-44.

Figure 3-43 Remote Controller Screen After User Sets +Long Beam Position Interlock Limit

Figure 3-44 Profiles Page 1 After All Four Beam Position Interlock Limits Are Reset

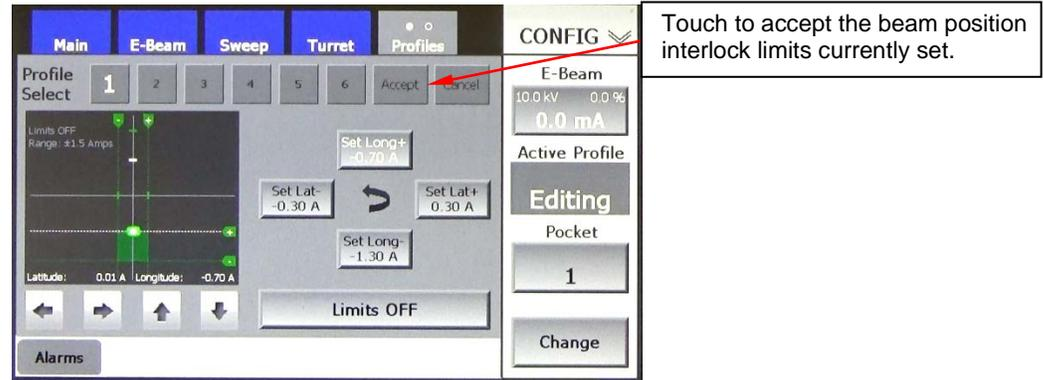

- 18 Touch the **Accept** button to accept the beam position interlock limits you have set. Profiles Page 1 will then appear as shown in Figure 3-45, with the beam position limits for this Profile indicated above and below and on either side of the Mode A/Mode B toggle button.

Figure 3-45 Profiles Page 1 After User Accepts the New Beam Position Interlock Limits



- 19 Select the next Profile whose beam limits you wish to set.
- 20 Rotate the turret to a pocket associated with that Profile.
- 21 Repeat Steps 10-18 to configure beam position limits for that Profile that you have associated with pockets in your turret source.
- 22 Repeat Steps 10-21 to set beam position limits for any Profiles that remain to be configured.

Figure 3-46 shows how the Operations>Sweep screen will appear when any pocket associated with Profile 1 is selected and with beam limits for that Profile set as described above. Note that the area demarcated by those beam position limits (outlined in green in Figure 3-46) are scaled to occupy most of the beam position/beam sweep grid, regardless of the size of the bounding box displayed in Configuration mode.

Figure 3-46 Operations>Sweep Screen After Beam Position Limits Are Set



Profile configuration is now completed. If you wish to enable the login manager and, optionally, change user passcodes and permission, perform the procedure described in section 3.8. Otherwise, exit from Configuration mode and save your configuration changes, as described in section 3.10.

3.8 Enabling the LogIn Manager and Changing User Passcodes and Permissions

To enable the LogIn manager and, optionally, change user passcodes and permissions, perform the procedure described below.

- | Step | Action |
|------|---|
| 1 | To display the LogIn Manager page, touch the screen tab of the Config>Main screen (see Figure 3-47). The LogIn Manager screen will then appear as shown in Figure 3-48. |

Figure 3-47 The Config>Main Screen

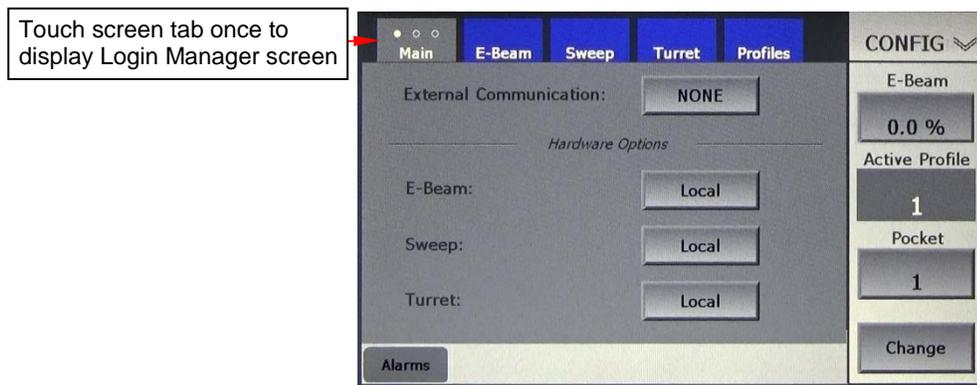
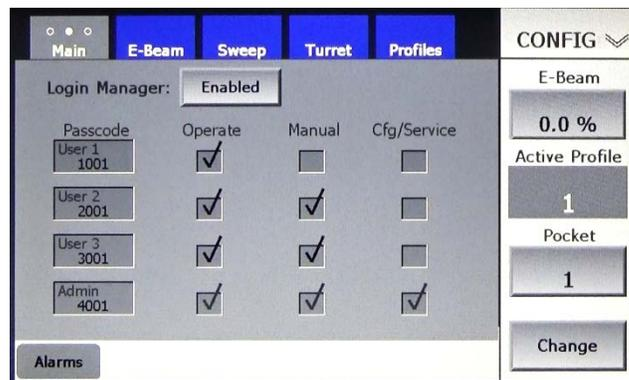

Figure 3-48 The LogIn Manager Screen When Initially Displayed



- 2 To enable the password manager function, touch this screen's **Disabled** button. Figure 3-49 shows the Login Manager screen after the LogIn Manager is enabled, with default passcodes and permissions in place.

Figure 3-49 Login Manager Screen After Login Manager Is Enabled



- 3 To change a given user's passcode, first touch the recessed button bearing that user's username to display a numeric keypad. Use that keypad to enter the new passcode and then touch the keypad's **Enter** button to close it. The new passcode will then appear in the recessed button you touched.
- 4 To change a user's permissions, add or delete check marks as desired by touching one or more of the checkboxes to the right of recessed button bearing that user's username.

Implementation of the LogIn Manager is now complete. If at any time you wish to disable the Login Manager, simply display the LogIn Manager screen and touch the **Enabled** button.

If you have finished configuring the Genius II, save your changes, as described in section 3.10.

3.9 Language Selection

Perform the following steps to select Russian instead of the default language, English.

- | Step | Action |
|------|--|
| 1 | Touch the Mode ID/Menu Selection button to display the alternative menu (see Figure 3-50). |

Figure 3-50 Configuration Mode Screen with Alternative Menu Displayed

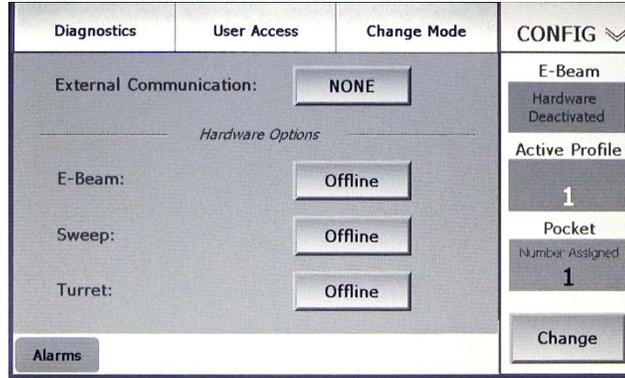

- 1 Touch this menu's **Diagnostics** button to display the Diagnostics screen (see Figure 3-51).

Figure 3-51 Diagnostics Screen

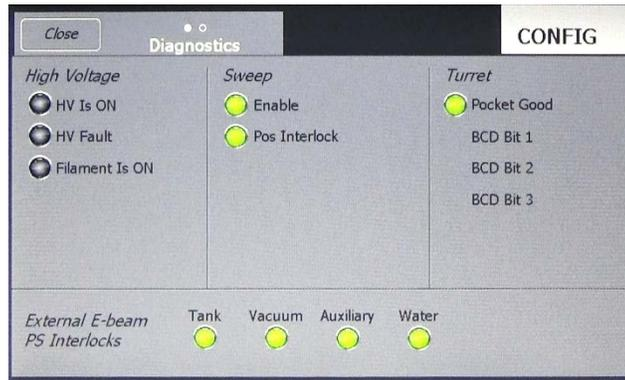

- 2 Touch the dots above the label **Diagnostics** to display the Language Selection/Software Version screen (see Figure 3-52).

Figure 3-52 Language Selection/Software Version Screen

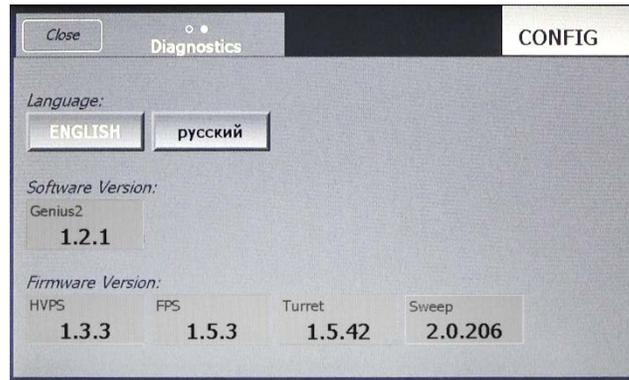

- 3 Touch the *Language* button whose label is in Cyrillic script.

3.10 Exiting Configuration Mode and Saving Configuration Changes

Configuration changes are automatically saved when you exit from Configuration Mode. To do so, perform the procedure described below.

| Step | Action |
|------|--|
| 1 | Touch the Menu Bar's Config button to display the Auxiliary Menu, (see Figure 3-53). That illustration shows the LogIn Manager screen, but you can exit from Configuration mode from any Configuration Mode screen. |

Figure 3-53 Login Manger Screen with Alternative Menu Displayed

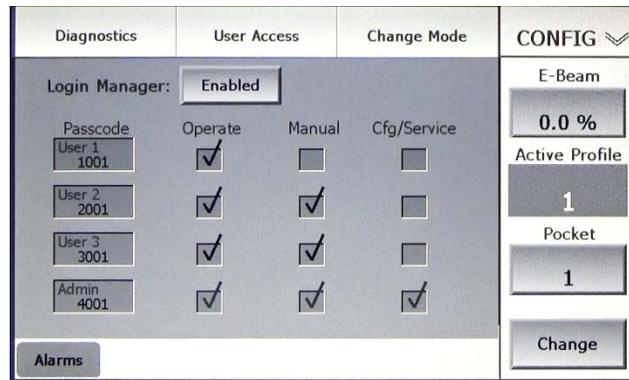

- 2 Touch the Auxiliary Menu's **Change Mode** button to display the mode-select popup shown in Figure 3-54.

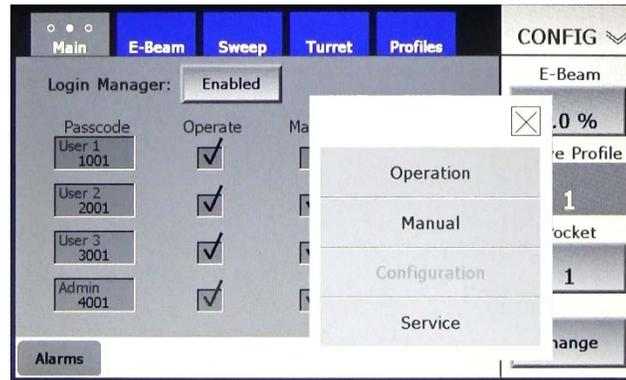
Figure 3-54 User Exiting Configuration Mode, Mode Select Popup Displayed

- 3 To exit from Configuration Mode and save your changes, touch any active button on this menu. The unit will then enter the selected mode.

The Genius II is now ready for operation in stand-alone mode.

4 *Operational Overview*

4.1 Section Overview

This section provides describes basic Genius II operational procedures and details about the main user interface (i.e., the main controller's touchscreen). For information about the control/display features of the hand-held controller, see section 1.4. The topics covered in this section are:

Section 4.2 Powering Up the Genius II

Section 4.3 Logging In and Logging Off

Section 4.3.1 Entering the System when the LogIn Manager Is Disabled

Section 4.3.2 Logging In

Section 4.3.3 Logging Off

Section 4.4 Navigating Between Operating Modes

Section 4.5 Responding to Alarms

Section 4.5.1 The Alarms Screen

Section 14.6 The Main Controller's Touch Screen

Section 4.6.1 Functional Overview

Section 4.6.2 The Main and Auxiliary Menus

Section 4.7 General Operating Methods

Section 4.7.1 Using the Function Control Buttons to Alter Operating Values

Section 4.7.2 Using the Function Control Buttons to Activate and Deactivate Controlled Devices

Section 4.7.2 Command Buttons Not on the Command Button Bar

Section 4.7.3 Parameter Selection and Parameter Value Entry Buttons

Section 4.7.4 ON/OFF Indicators

Section 4.8 Changes in Main UI Screens Depending on Configuration

Section 4.8.1 UI Changes Resulting from a Control Module Being Configured as Offline

Section 4.8.2 Screen Changes Resulting from a Given Control Module Being Configured as Remote I/O

4.2 Powering Up the Genius II

Before powering up the Genius II, first make sure the rear-panel On/Off switch (see Figure 2-9) is in the On position. Then press the front panel On/Off switch (see Figure 1-1). After the unit boots up, it will display either the Boot-Up screen (see Figure 4-1) or the LogIn screen (see Figure 4-2), depending on whether the log-in manager is enabled.

4.3 Logging In and Logging Off

The Genius II automatically displays the splash screen shown in Figure 4-1 after the unit initially boots up. In this unconfigured state, the log-in manager is disabled by default.

Figure 4-1 Genius II Boot-Up Screen when Initially Displayed

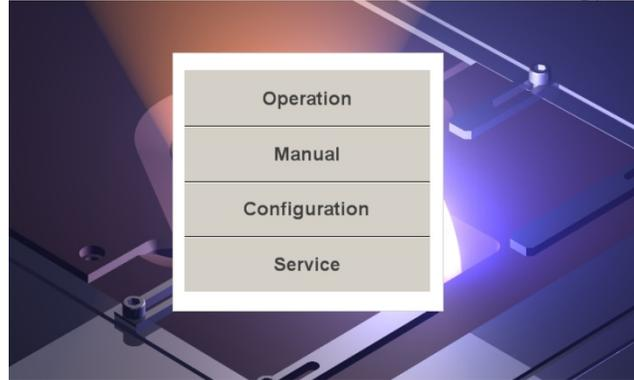

4.3.1 Entering the System when the LogIn Manager Is Disabled

When the LogIn manager is disabled, you can enter the desired operating mode by touching the appropriate mode-selection button on the splash screen.

4.3.2 Logging In when the LogIn Manager Is Enabled

When the LogIn manager is enabled, the initial screen will display a login popup on boot-up, as shown in Figure 4-2. To log-in, perform the following procedure.

Figure 4-2 Genius II LogIn Screen

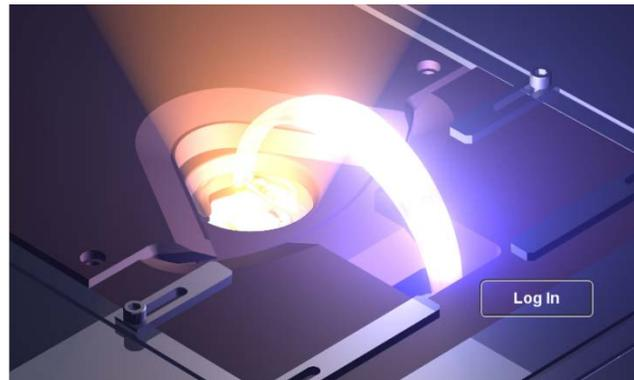

| Step | Action |
|------|---|
| 1 | Touch the Log In button. A password entry box will then appear screen, as shown in Figure 4-3. |

Figure 4-3 Splash Screen with LogIn Popup Displayed

- 2 Enter your passcode and then touch the X in the upper right-hand corner of the popup to close it.

The touch screen will then display an Operations mode screen.

4.3.3 Logging Off

To log off, follow the procedure described below.

- | Step | Action |
|------|--|
| 1 | Touch the Menu Selection/Mode ID button (see Figure 4-4) to display the Auxiliary Menu (see Figure 4-5). |

Figure 4-4 Operations>Main Screen with Standard Menu Displayed

Figure 4-5 Operations>Main Screen with Auxiliary Menu Displayed



- 2 Touch the **Log Off** button. The screen will then display the log-off popup (see Figure 4-6).

Figure 4-6 Log-Off Popup

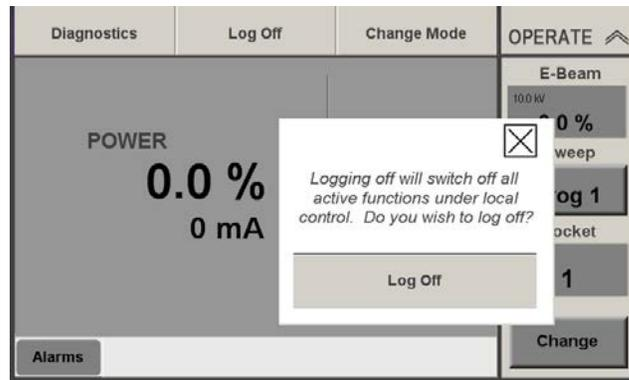

- 3 If you're sure you wish to log-off, touch the popup's **Log Off** button. The LogIn screen (see Figure 4-2) will then be displayed.

4.4 Navigating Between Operating Modes

The following procedure describes how to switch from one Genius II operating mode to any other.

- | Step | Action |
|------|--|
| 1 | Touch the Menu Selection/Mode ID button (see Figure 4-4) to display the Auxiliary Menu bar (see Figure 4-5). |
| 2 | Touch the Change Mode button to display the Change Mode popup. Figure 4-7 shows that popup as it appears to a user with access to all four operating modes. |

Figure 4-7 Local>Main Screen with Change Mode Popup Displayed

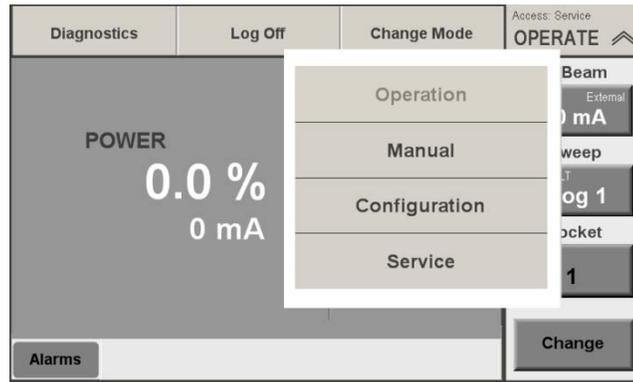

- 3 Touch the button for the mode which you want to enter. The unit will then switch to that mode.

4.5 Responding to Alarms

When an alarm occurs, the main UI displays an alarm message, and the **Alarms** button turns red, as shown in Figure 4-8. To clear the alarm, first correct the condition that triggered the alarm and then click the **Alarms** button.

Figure 4-8 Main User Interface Displaying an Alarm Message

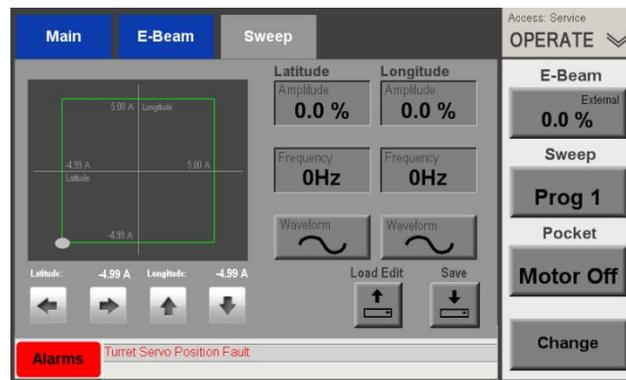

4.5.1 The Alarms Screen

The Alarm screen allows the user to view active and past alarms and to acknowledge active alarms. The Alarms screen is available from any Configuration, Operations, or Manual mode screen. To access the Alarms screen from any such screen, press its **Alarms** button. Figures 4-9 and 4-10 show how the Alarms screen would appear if the user touched the **Alarms** button on the screen shown in Figure 4-8. If **Exclude History** were previously selected via the **Alarms** screen, the Alarms screen would appear as shown in Figure 4-9. If **Include History** was previously selected, then the Alarms screen would appear similar to that shown in Figure 4-10.

To acknowledge all active alarms, simply touch the red **Acknowledge** button.

Figure 4-9 Alarm Details Screen with Active Alarms, *Exclude History* Selected



Figure 4-10 Alarm Details Screen with Active Alarms, *Exclude History* Selected



4.6 The Main Controller's Touch Screen

4.6.1 Functional Overview

Figure 4-11 identifies the functionally distinct areas of the touch screen as it appears in Configuration, Operations, and Manual modes. Those functional areas are defined below the illustration. Service mode screens are organized differently. For detailed descriptions of those screens, see section 8.3.

Figure 4-11 Functional Areas of Genius II User Interface as It Appears in Configuration, Operations, and Manual Modes

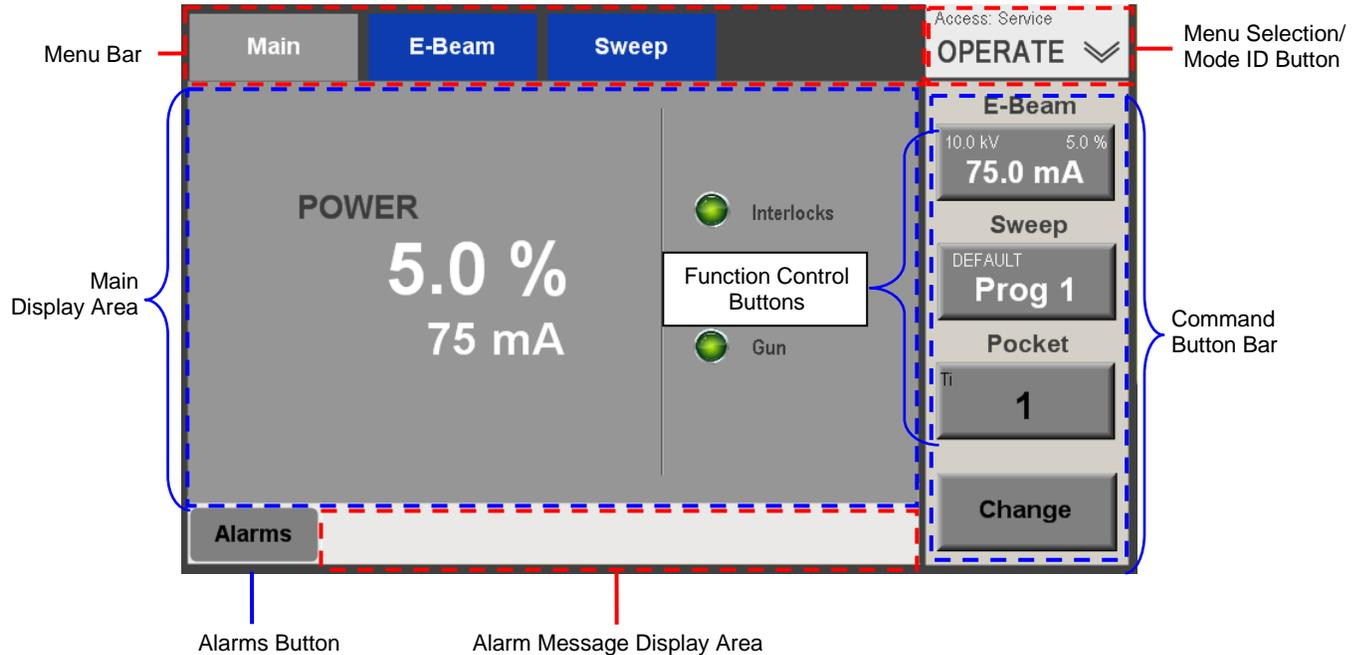

- **Menu Selection/Mode ID Button:** This button identifies the operation mode currently selected. Touch it to toggle between the Main and Auxiliary menus.
- **Menu bar:** Displays either the Main Menu or the Auxiliary Menu. Figure 4-11 shows the Main Menu, while Figure 4-12 shows the Auxiliary Menu.
- **Main Display Area:** This area displays the functionally specific areas of the screens available in Configuration, Operations, and Manual modes (see Figures 1-7 through 1-11).
- **Command Button Bar:** The Function Control buttons on this button bar allow the user to initiate turret rotation and to switch the e-beam and the sweep on and off. In conjunction with the **CHANGE** button, the Function Control buttons also enable the user to change the beam's percent-power value and to change the sweep program and pocket selections. For detailed information about how these buttons function, see section 0.
- **Alarm Message Display Area:** Displays notifications of currently active alarm messages.
- **Alarms button:** Touch to display the Alarms screen (see Figure 4-9).

4.6.2 The Main and Auxiliary Menus

In all operating modes, the user can display either the Main Menu (see Figure 4-11) or the Auxiliary Menu (see Figure 4-12). The Main Menu allows the user to display the screens that are functionally unique to the operating mode currently selected. The Auxiliary Menu enables the user to change the Genius II operating mode and to display the Diagnostics screen (see Figures 8-2 and 8-3). For detailed information about the Diagnostics screen, see section 8.2.

Figure 4-12 Local>Main Screen with Auxiliary Menu Displayed



4.7 General Operating Methods

4.7.1 Buttons on the Command Button Bar

The buttons on the Command Button Bar (see Figure 4-11) include the **CHANGE** button and three Function Control buttons, which enable the user to:

- change the operating value of the function controlled by the button in question (i.e., change the percentage of power applied when the e-beam is switched on, change the sweep program selection, or change the pocket selection). Detailed instructions are provided immediately below.
- activate the function in question (i.e., switch the e-beam and the sweep on/off and rotate the turret). For detailed instructions, see "Using the Function Control Buttons to Activate and Deactivate Controlled Devices" on page 4-10.

Each Function Control button displays the current operating value of the device/function in question. Thus, the **E-Beam On/Off** button displays the percentage of e-beam power applied as well as the kV value, while the **Sweep Enable** button displays number of the sweep program currently selected, and the **Next Pocket** button displays the number of the pocket currently selected. The legend on a given button turns white when the function controlled by that button is operating.

Using the Function Control Buttons to Alter Operating Values

To change the operating value for any of the three functions controlled by the unit, perform the following procedure.

| Step | Action |
|------|---|
| 1 | Press the ADJUST button. Doing so turns the Function Control buttons white (see Figure 4-13), indicating that the parameters selectable via all three buttons can be modified. |

Figure 4-13 Command Button Bar After User Presses the CHANGE Button



- 1 Touch the button controlling the desired function to display a numeric keypad (e.g., Figure 4-14) that will allow you enter a different value. The keypad displayed indicates the maximum and minimum values for the parameter you have selected for modification. In Figure 4-14, the user has opened a keypad by touching the **E-Beam** button, so the Min. and Max. values are 0.0 and 100.0, respectively.

Figure 4-14 Numeric Keypad for Entering a Beam Power Percentage Setpoint

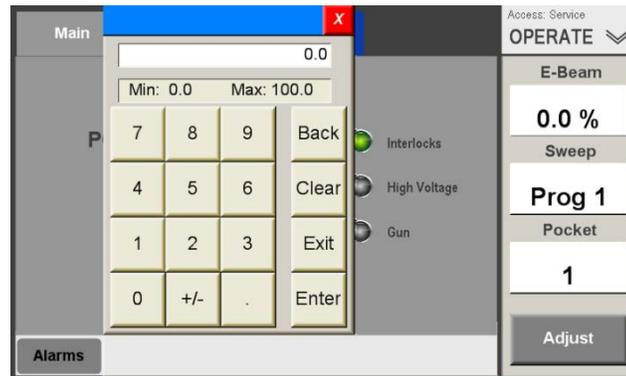

- 2 Enter the desired operating value. For e-beam power, enter a value between 0.1% and 100%. For sweep program number, enter a value between 1 and 33. For pocket number, enter a value between 1 and the highest-numbered pocket in your turret source. In Figure 4-15 the user has entered 5% as an e-beam power setpoint.

Figure 4-15 User Has Entered 5% Power Setpoint via Numeric Keypad

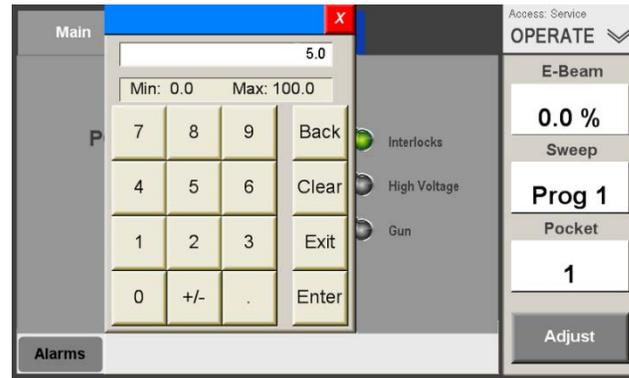

- 3 Touch the keypad's **Enter** button to close it. The white highlighting will then disappear from the function-control button(s), and the new operating value will be displayed on the button controlling the function whose operating value you changed. In Figure 4-16, the **E-Beam** button displays 5.0%, reflecting the change made in Figure 4-15. If you have changed the pocket selection, the turret will begin rotating to the target pocket as soon you close the numeric keypad. Note that you can change the target pocket while the turret is rotating.

Figure 4-16 E-Beam Button After User Sets 5% as Beam Power Setpoint



Using the Function Control Buttons to Activate and Deactivate Controlled Devices

To activate a given device function at the operating value currently displayed, simply touch the button controlling that function when the function-control buttons are not highlighted in white.

Switching the E-Beam On/Off : You can use the **E-Beam On/Off** button in either of two ways to switch on the e-beam, depending on whether the power setpoint is a nonzero value or not.

1. **Power setpoint = 0%:** If you press the **E-Beam** button when the power setpoint is zero, the button will turn white, indicating that the beam is on. You must then follow the procedure described above to enter a nonzero setpoint. After you click **Enter** to close the on-screen keypad, the unit will ramp up the beam power to the setpoint value you entered.

2. **Nonzero power setpoint already entered.** If you have already performed the above procedure to enter a nonzero power setpoint, that value will appear in black on the **E-Beam** button. At that point, pressing that button will switch on the beam and ramp the power up to the indicated setpoint.

When the beam is on, the current percent-power setpoint appears in white. To switch the beam off when it is on, touch the **E-Beam** button. The power setpoint will then default to zero percent, and **0%** will appear on the button.

Switching the Sweep On/Off: To switch on the beam sweep when it is off, touch the **Sweep** button. The Genius II will then activate the sweep program whose number is currently displayed on that button. The legend **Prog N** will then turn white, indicating that the beam sweep is active. To switch off the beam sweep when it is operating, touch the **Sweep** button again. The legend **Prog N** will then turn black again.

Rotating the Turret: There are two methods of rotating the turret, depending on whether you wish to rotate it to next pocket or to some other pocket position:

1. To rotate the turret to the next pocket, simply touch the **Pocket** button. It is not necessary to display the keypad and enter the number of the next pocket in ascending order.
2. To rotate the turret to a pocket other than the next one in ascending order, first enter the desired pocket number, following the procedure described in section 0. When you touch **Enter** to close the numeric keypad, the turret will begin to rotate to the pocket whose number you entered.

While the turret is rotating, the word **SEEKING** appears in white on the **Pocket** button, with the smaller legend **Target: Y** (where Y = the number of the target pocket) above it. In Figure 4-17, the target pocket is **3**. When the turret reaches the target pocket position, the legend **Target: Y** disappears, and the number of the current pocket again appears on the button.

Figure 4-17 Pocket Button When Turret Is Rotating



4.7.2 Command Buttons Not on the Command Button Bar

In addition to those on the Command Button Bar, user-controllable command buttons appear on numerous mode-specific screens accessible via the Main Menu, including:

- On/Off toggle buttons like those that serve to switch on/off the gun and HV on the E-Beam screen in all operating modes

- the arrow buttons on Profiles Page 1 that enable the user to move the beam spot or the sweep pattern
- press-once command buttons like the **Set** buttons on Profiles Page 1 that enable the user to set the beam position limits
- press-and-hold-down command keys like the **Seek CW** and **Seek CCW** buttons that appear on the Config>Turret screen
- the screen navigation buttons that appear on the Main Menu bar in all operating modes

As previously described, the Menu selection/Mode ID button (see Figure 4-11) operates as a dual-state toggle button.

4.7.3 Parameter Selection and Parameter Value Entry Buttons

Parameter entry and parameter selection buttons appear on the Command Button Bar, as described in section 4.5, and on the screens accessible via the Main Menu Bar. Parameter selection buttons include:

- two-state toggle buttons like the **Emis Control** button on the Configuration>E-Beam screen
- buttons that the user presses repeatedly to step through the available selections (e.g., the **Pkt. Motion** and **Pockets** buttons on the Configuration>Turret screen and the **Waveform** buttons displayed on the Manual>Sweep screen and on the Operations>Sweep screen when the sweep control module is configured as **Local**).

Parameter value-entry buttons look similar to parameter-display rectangles, but the former are raised, and numeric keypads are displayed when they are pressed. Examples are the **Amplitude** and **Frequency** buttons on the Manual>Sweep screen and on the Operations>Sweep screen when the sweep control module is configured as **Local**. When one of these buttons is pressed, the screen displays a numeric keypad that allows the user to enter the desired parameter value. Section 0 describes a typical procedure entering a parameter value via one of these buttons.

4.7.4 ON/OFF Indicators

Standard ON/OFF indicators

In general, when a given function is off, the button-top labels and value-display numerals pertaining to that function are black. When that function is switched on, the relevant button-top labels and value-display numerals turn white. For example, when the gun is on, the **Gun ON** button's label and the values displayed in the **Emission**, **Filament**, and **Max. Powr** parameter-display rectangles are white, as shown in Figure 4-18. When the gun is off, the **Gun ON** button's label and the values displayed in those rectangles are black.

Figure 4-18 Operations>E-Beam Screen when Gun is ON and HV is OFF

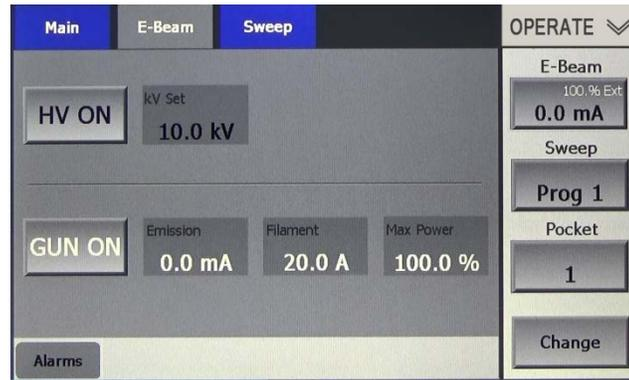

Output Asserted/Not Asserted Indicators on Service Mode Screens

Service Mode screens have numerous command buttons that enable the user to assert or de-assert a given Genius II output. A small square in the upper left-hand corner of such buttons turns green when the output in question is asserted. Examples of such buttons are the **HVPS ON** and **FPS ON** buttons on the Service>E-Beam screen (see Figure 8-4).

4.8 Changes in Main UI Screens Depending on Configuration

The screens displayed by Genius II's main UI change in numerous ways depending on how a given unit is configured.

4.8.1 UI Changes Resulting from a Control Module Being Configured as Offline

Figures 4-19 and 4-20 illustrate how various screens change in appearance when a given control module is configured as **Offline**. For example, when the sweep control module is configured as **Offline**, the Ops>Sweep screen and its Main menu tab disappear, and that a flat rectangle with the legend **Hardware Deactivated** replaces the **Sweep** button in the control button bar (see Figure 4-19). On the Diagnostics screen, a gray rectangle bearing the legend **Not Installed** replaces all sweep-related LEDs when the sweep control module is offline, as shown in Figure 4-20.

Figure 4-19 Changes to Ops>Main Screen When Sweep Module Is Configured as Offline

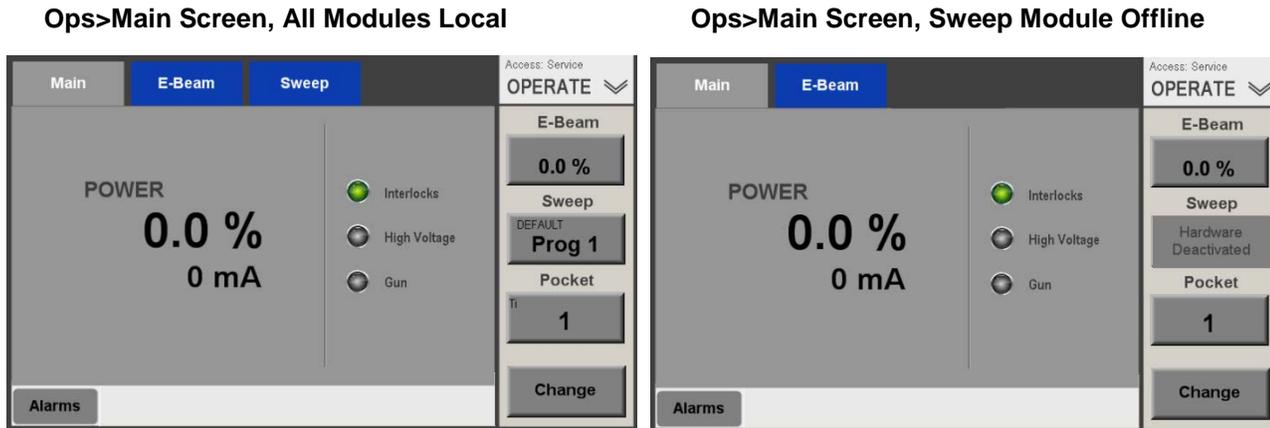
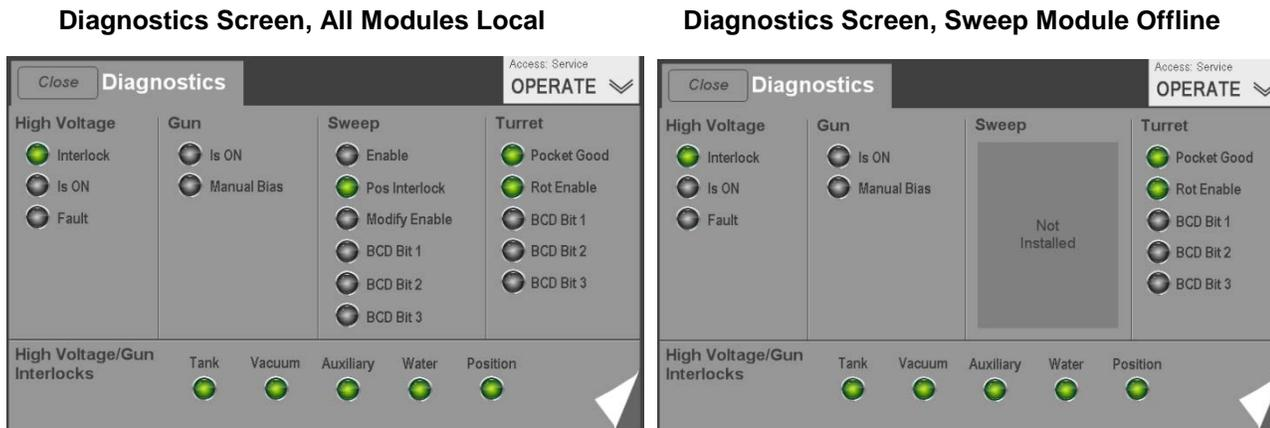

Figure 4-20 Changes to Diagnostics Screen When Sweep Module Is Configured as Offline



4.8.2 Screen Changes Resulting from a Given Control Module Being Configured as *Remote I/O*

When a given control module is configured as Remote, the Operations mode screen for that control module change in the following ways:

1. The function-control button for the function in question on the control button bar becomes a flat parameter-value display rectangle.
2. The control button bar's **Change** button disappears.
3. All parameter-value entry rectangles relating to the function in question likewise become flat parameter-value display rectangles.
4. All on-screen control buttons relating to that function disappear from the screen.

Figure 4-21 shows how these changes are applied to the Ops>Sweep when the sweep control module is configured as **Remote I/O**.

Figure 4-21 Changes to Ops>Sweep Screen When Sweep Module Is Configured as Remote I/O

Sweep Module Configured as Local



Sweep Module Configured as Remote I/O



5 *Stand Alone Operation of the Genius II*

5.1 Section Overview

This section describes how to operate the Genius II when all control modules are configured as **Local** (i.e., when the Genius II is not connected to a higher-level controller). The topics covered in this section are:

- Section 5.2 Installation and Configuration
- Section 5.3 Use of the Function Control Buttons on the Main UI's Main Button Bar
- Section 5.4 The Operations>Main Screen
- Section 5.5 Operating and Monitoring the E-Beam Power Supply
 - Section 5.5.1 Using the E-BEAM Button to Switch the Beam On/Off
 - Section 5.5.2 Setting the Beam Power Level
 - Section 5.5.3 Switching on the HV and Gun Independently of Each Other
- Section 5.6 Creating and Modifying Sweep Programs
 - Section 5.5.3 Switching on the HV and Gun Independently of Each Other
 - Section 5.5.1 Using the E-BEAM Button to Switch the Beam On/Off
 - Section 5.5.2 Setting the Beam Power Level
 - Section 5.6.3 Modifying a Sweep Program Other than the Program Currently Displayed
 - Section 5.6.4 Making Multiple Backup Copies of a Sweep Pattern
 - Section 5.6.5 Importing and Modifying Sweep Patterns with Arbitrary Waveforms
- Section 5.7 Genius II Operation from the Hand-Held Remote Controller
 - Section 5.7.1 Control Functions Available Via the Remote Controller when the Genius II Is In Operations Mode
 - Section 5.7.2 Control Functions Available Via Menu 1
 - Section 5.7.3 Control Functions Available Via Menu 2

NOTE

When all control modules are configured as **Remote I/O**, **EtherCAT**, or **RS232**, operation in Manual mode is identical to operation in Operations mode when all control modules are configured as **Local**.

5.2 Installation and Configuration

Installation and cabling for stand-alone Genius II operation is as described in Section 2 of this manual. Configuration for such operation is as described in Section 3.

5.3 Use of the Function Control Buttons on the Main UI's Main Button Bar

For a detailed explanation of the functions of these buttons see section 2.7.1.

5.4 The Operations>Main Screen

Figure 5-1 shows the Operations>Main screen.

Figure 5-1 Operations>Main Screen



The display features of this screen are:

- The **POWER** readouts, displayed in percentage and milliampere terms. When the beam is on, these readouts are white.
- The **Interlocks** LED. This LED is green when all interlocks are made and turns red when one or more interlocks are not made. When that occurs, check the Diagnostics screen (see Figures 8-2 and 8-3) to begin troubleshooting the problem.
- The **High Voltage** LED, which turns green when the HV is switched on, assuming that no HV faults are in force, in which case this LED turns red.
- The **GUN** LED, which turns green when the gun is switched on, assuming that no gun faults are in force, in which case this LED turns red.

5.5 Operating and Monitoring the E-Beam Power Supply

5.5.1 Using the E-BEAM Button to Switch the Beam On/Off

You can switch the beam on/off by simply touching the **E-BEAM** button. When the beam is on, the HV readouts and the gun readouts in mA and percentage terms are displayed in white, as shown in Figure 5-2.

Figure 5-2 Operations>E-Beam Screen, Beam On at 0.0 mA

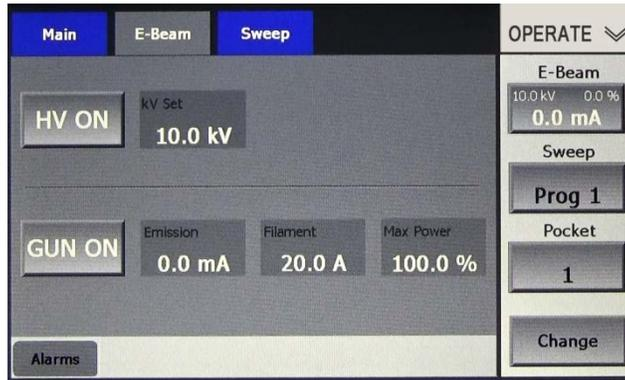

NOTE

When the E-Beam control module is configured as **Local**, you can also switch the beam on and off from the hand-held remote controller. To do so, see the instructions in section 5.7.2.

5.5.2 Setting the Beam Power Level

To set the beam power level, first touch the **Change** button, then touch the **E-Beam** button. The Genius II will then display a keypad screen, which you can use to enter a percent-power setpoint. After doing so, touch the keypad's **Enter** button to close it. The power supply will then ramp up to that power setpoint. In Figure 5-3, the user has used the keypad to enter **5**. Figure 5-4 shows the Ops>E-Beam screen after the user has closed the numeric keypad. The beam is now operating at 5% power, which translates to 75 mA of emission current for the power supply selected. Note that the beam power level can be adjusted with the beam either on or off.

Figure 5-3 Operations E-Beam Screen with Numeric Keypad Displayed

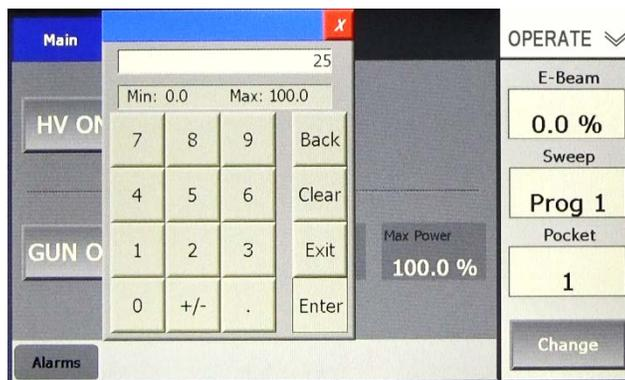
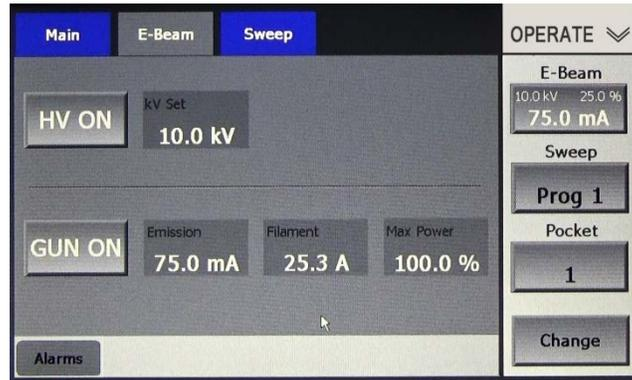

Figure 5-4 Operations>E-Beam Screen, Beam on at 5% Power



5.5.3 Switching on the HV and Gun Independently of Each Other

The **HV ON** and **Gun ON** buttons on the Operations>E-Beam screen allow you to switch the HV and gun on/off independently of each other. To switch the HV on/off independently of the gun, simply touch the **HV ON** button. Likewise, to switch the gun on/off independently of the HV, touch the **GUN ON** button. You can also switch on the beam by touching both the **HV ON** and **GUN ON** buttons, in either order. Figure 5-5 shows the Operations>E-Beam screen when the HV and the gun are both off.

Figure 5-5 Operations>E-Beam Screen when HV and Gun Are Both Switched Off

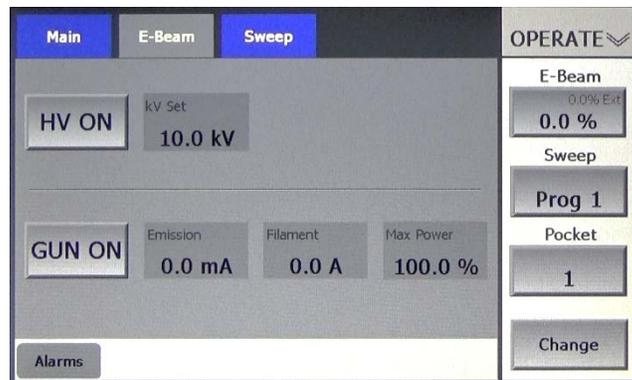
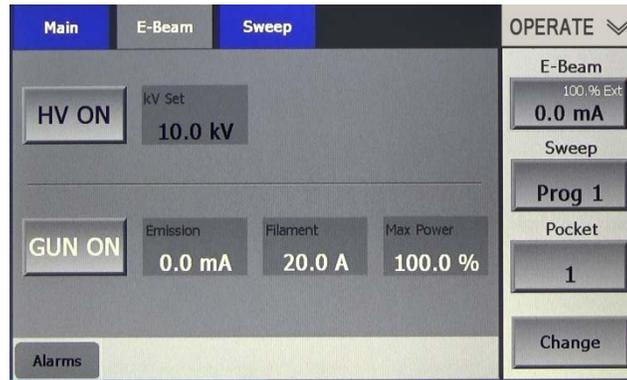

Figure 5-6 shows the Operations E-Beam screen when the gun is on and the HV is off.

Figure 5-6 Operations>E-Beam Screen when Gun is ON and HV is OFF



5.6 Creating and Modifying Sweep Programs

Beam sweep programs are created and modified using the Operations>Sweep screen. Section 5.6.1 describes the features of that screen. Section 5.6.2 describes how to modify the sweep program currently selected via that screen, while section 5.6.3 describes how to modify a program other than the one currently selected. Section 5.6.4 describes how to make multiple copies of a sweep program, and section 5.6.5 describes how to import and modify sweep programs with user-defined (i.e., 'arbitrary') waveforms.

5.6.1 Control/Display Features of the Operations>Sweep Screen

Figure 5-7 shows the Operations>Sweep screen when the sweep control module is in editing mode (i.e., when a user is editing a sweep program). In that illustration, the screen's control display features are labeled. Those features, which are described in detail below the illustration, allow you to:

- configure sweep parameters
- observe the sweep pattern (regardless of whether the beam is on or not), and
- change either the beam's static location (if the sweep is disabled) or the center point of the selected sweep pattern.

In addition, the **SWEEP** button on the command button bar allows you to select a sweep program and to switch it on/off. To switch the currently selected program on/off, touch that button once. To select a different program, touch the **Sweep** button, touch the **Change** button, use the keypad that will then appear to enter the number of the program you wish to select, and then touch the keypad's **Enter** button to close it. The number of the program you selected will then appear on the **Sweep** button.

Figure 5-7 Operations>Sweep Screen in Editing Mode, Beam Off, Sweep On

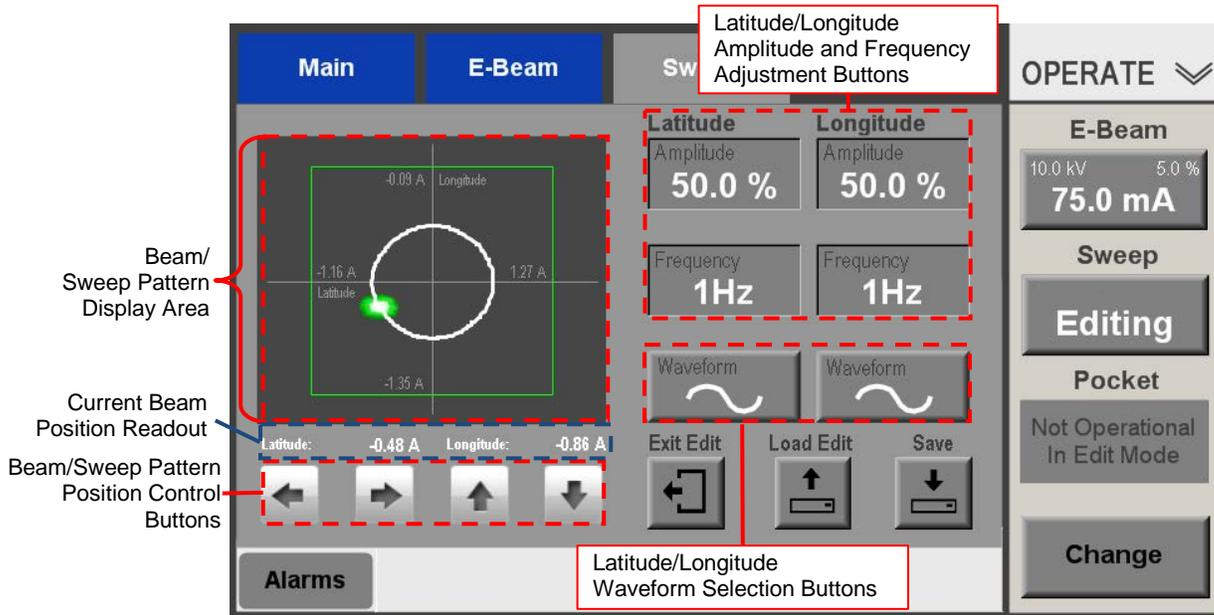

Beam/Sweep Pattern Display Area. If the sweep is disabled, this grid displays the beam's current position. If the sweep is enabled, the grid displays the pattern of the sweep program currently selected. When the beam is off, its position is represented by a white oval with a green halo, as shown in Figure 5-7. When the beam is off, the beam spot appears as a simple white oval, as shown in Figure 5-8. The green rectangle outlines the area defined by the current beam-position interlock limits. Those limits are determined by the coil-drive outputs whose values are displayed along the lines that represent the longitudinal and lateral axes.

Figure 5-8 Ops>Sweep Screen, Not in Edit Mode, Sweep On, Beam Off

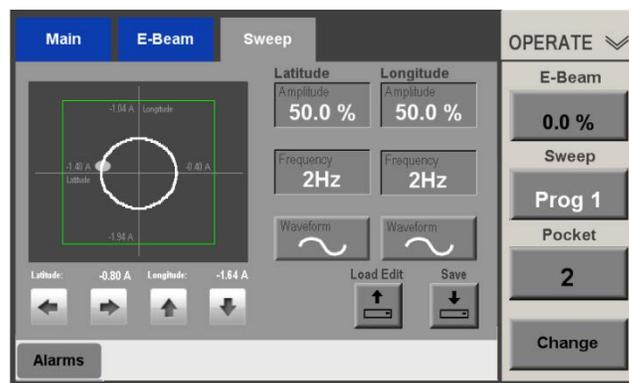

Current Beam Position Readout. The values displayed in white immediately below the beam/sweep pattern display area indicate the values, in amperes, of the longitudinal and latitudinal coil-drive outputs that determine the beam's current position.

Beam/Sweep Pattern Location Control Buttons. If the sweep is disabled, touching one of these buttons moves the beam in the direction indicated. That beam position becomes the center point of the sweep pattern when the sweep is enabled. If the sweep is enabled, touching one of these buttons moves the sweep pattern as a whole in the direction indicated.

Latitude and **Longitude** sweep parameter entry/selection buttons. Touching either of the **Amplitude** and **Frequency** buttons opens a numeric keypad that allows you to enter the desired value for the parameter in question. Touching either of the **Waveform** buttons selects the next waveform. The waveform options, in order of display, are Sine () , Ramped () , Sawtooth () , Clipped () , and arbitrary.

NOTE

You can also use the hand-held remote controller to change a sweep program's waveform and to adjust its amplitude and frequency values. For instructions on doing so, see section 5.7.3.

Save button. Touching this button displays the **Save Target** popup (see Figure 5-13), which allows the user to save a set of sweep parameters.

Load Edit button. Touching this button displays the **Load Location** popup (see Figure 5-15) and puts the Genius II into sweep-edit mode, if it is not already in that mode. After you use that popup to enter the pocket number and program number of the sweep program you wish to edit, the Ops>Sweep screen will display that sweep pattern and its parameters. You can then edit that program while the previously displayed one is still operating, even if the beam is on.

Exit Edit button. This button appears only when the unit is in sweep-edit mode. Touching it causes the unit to exit from sweep-edit mode without saving any changes made to sweep programs during the current editing session.

5.6.2 Modifying the Sweep Program Currently Displayed

To modify the sweep program currently displayed, perform the procedure described below. Note that this procedure assumes that the Genius II is properly configured and that the Operations>Sweep screen is displayed on the Genius II touch screen.

| Step | Action |
|------|--|
| 1 | Display the Operations>Sweep screen, if it is not already displayed. |
| 2 | If necessary, rotate the turret to the desired pocket and select the sweep program that you wish to modify. |
| 3 | Switch on the beam and sweep, if they are currently not operating. Figure 5-9 shows the Operations>Sweep screen in this state. |

Figure 5-9 Ops>Sweep Screen, Beam and Sweep On

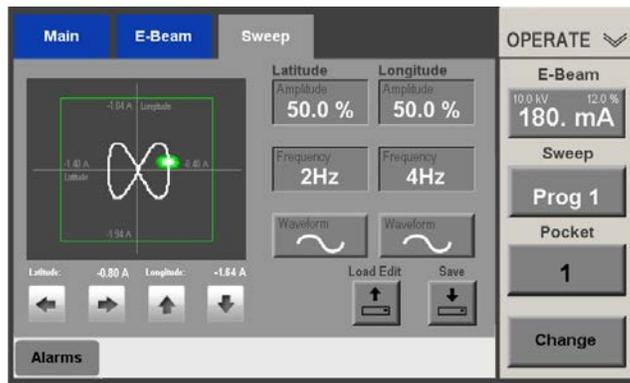

- 4 Touch the box for the sweep parameter you wish to modify. In Figure 5-10 the user has touched the **Latitude>Frequency** button to display the keypad shown.

Figure 5-10 Ops>Sweep Screen After User Touches the Longitude Frequency Button to Change the Value of that Sweep Parameter

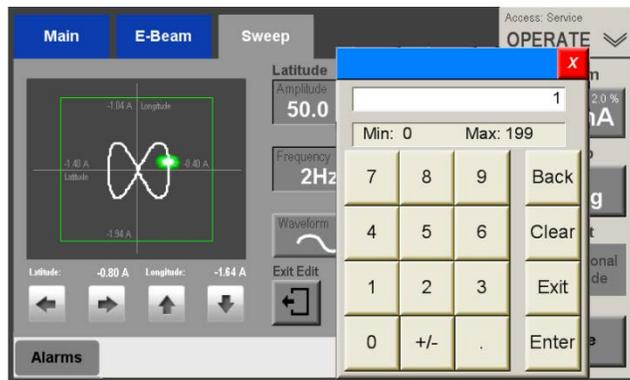

- 5 Enter the value desired for this parameter. In Figure 5-11 the user has entered 2.

Figure 5-11 Ops>Sweep Screen, User Has Entered 2 as New Longitude Frequency Value

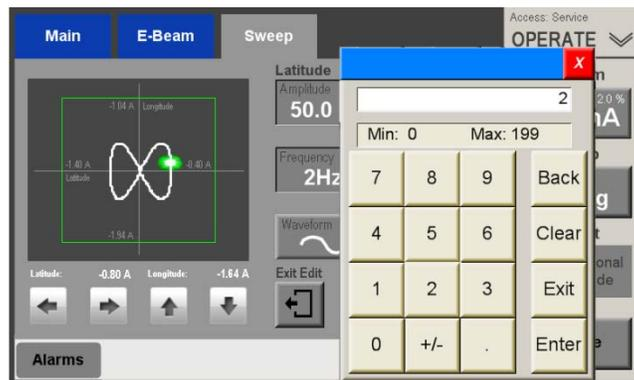

- 6 Touch the keypad's **Enter** button. The screen will then appear as shown in Figure 5-12. Note that the Genius II is still in sweep-edit mode.

Figure 5-12 Ops>Sweep Screen After User Changes Longitude Frequency to 2

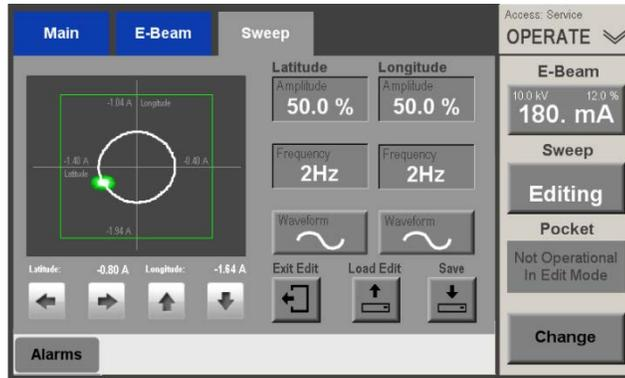

- 7 Repeat Steps 4-6 to modify any other numeric parameters you wish to change. If you wish to change either the Lateral or Longitudinal waveform, simply touch the appropriate **Waveform** button repeatedly until it displays the desired waveform.

NOTE

To apply an Arbitrary waveform, you must first import the desired sweep pattern file. For instructions on doing so, see section 5.6.5.

- 8 When you have made all the changes you wish to make to this program, touch the screen's **Save** button to display the **Save Target** popup (see Figure 5-13).

Figure 5-13 User Saving Change Made to Currently Operational Program

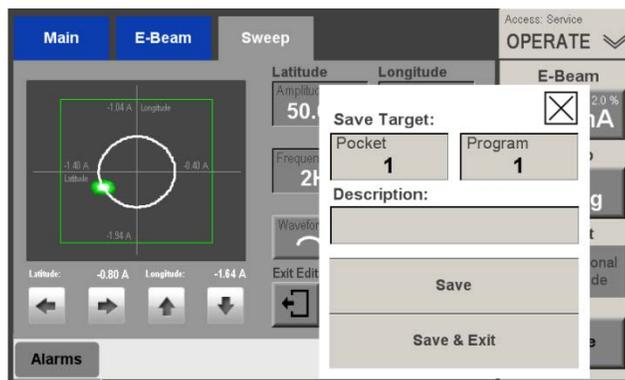

- 9 If you wish to save the changes you have entered to the same target program, touch the popup's **Save & Exit** button. After you do so, the screen will appear as shown in Figure 5-14.

Figure 5-14 Ops>Sweep Screen After User Saves Changes Made to Currently Displayed Program and Exits from Sweep-Edit Mode



5.6.3 Modifying a Sweep Program Other than the Program Currently Displayed

There are two different ways to modify a sweep program other than the one currently displayed. You can either:

- (1) Select the target program, using the **Sweep** button and, if necessary, **Pocket** button and then perform the procedure described in section 5.6.2. If the target program belongs to a pocket other than the one currently selected, then there you will have to wait for the turret to rotate to that pocket before editing the sweep program. Alternatively, you can:
- (2) Perform the procedure described below, using the Ops>Sweep screen's **Load Edit** button and **Load Location** popup to enable background editing of the target program. This approach eliminates any turret rotation that might otherwise have been necessary.

| Step | Action |
|------|---|
| 1 | Open the Operations>Sweep screen with any sweep program displayed, for example, the program shown in Figure 5-14. |
| 2 | Touch the screen's Load Edit button to display the Load Location popup (see Figure 5-15). When that popup initially appears, its Pocket and Program boxes will display the Pocket and Program identifiers of the sweep program currently displayed. |

Figure 5-15 Ops>Sweep Screen with *Load Location* Popup Displayed and Currently Displayed Sweep Program Selected

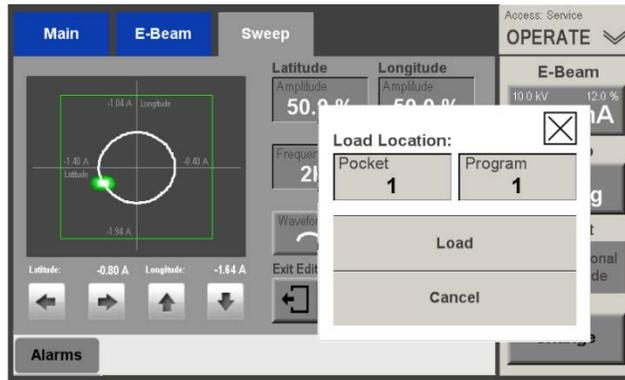

- 3 In the **Pocket** and/or **Program** boxes, enter the numbers designating the sweep program you wish to modify. In Figure 5-16 the user has entered 3 in the **Pocket** box and 2 in the **Program** box.

Figure 5-16 Load Location Popup with Pocket 3, Program 2 Entered

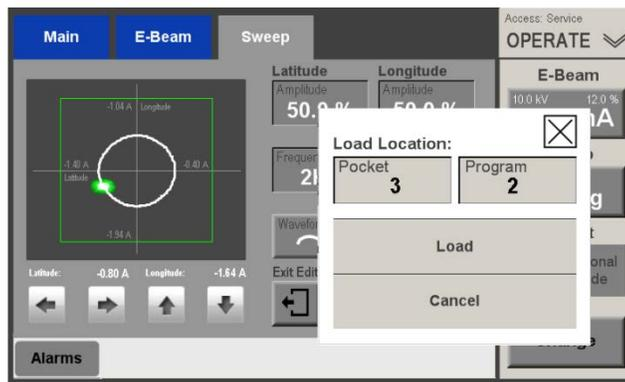

- 4 Touch the popup's **Load** button. After you do so, the screen will display the beam-sweep trace and parameters of the program you have selected using the **Load Location** popup. In this example, the screen would appear as in Figure 5-17, with Program 2 for Pocket 3 displayed for background editing.

Figure 5-17 Local Sweep Screen After Pocket 3, Program 2 Loaded For Background Editing

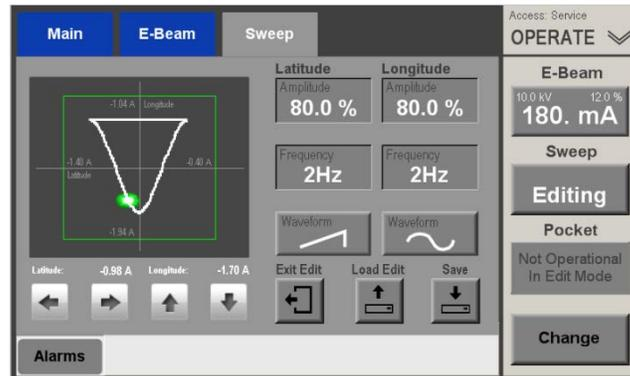

- 5 Edit the displayed sweep program as desired. As an example, in Figure 5-18 the user has changed the longitudinal frequency to 4 Hz and the latitudinal waveform to sine, yielding a 'bowtie' pattern.

Figure 5-18 The Program 3, Pocket 2 Sweep Pattern After User Makes Parameter Changes

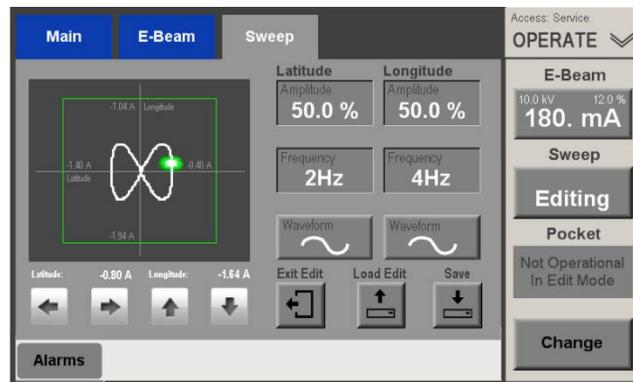

- 6 Touch the screen's **Save** button to display the **Save Target** popup. Note that this popup, when it first appears in this sequence of operations, displays the Pocket and Program numbers of the sweep program displayed by the Ops>Sweep screen when the procedure began. In this example, the **Save Target** popup displays Pocket 1 and Program 1 (see Figure 5-19).

Figure 5-19 Save Target Popup Displaying the Procedure's Original Pocket and Program

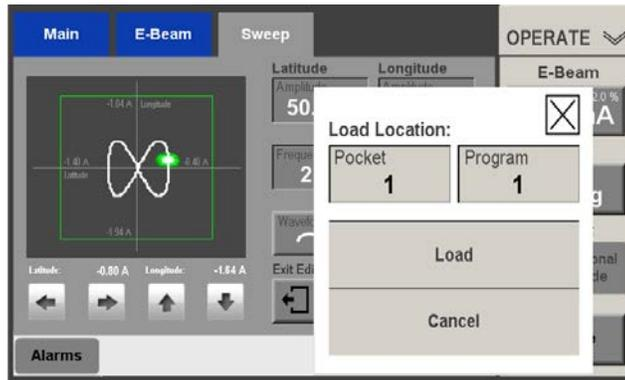

- 7 Change the entries in the popup's **Pocket** and **Program** boxes to the desired numbers. In Figure 5-20 the user has entered **3** for **Pocket** and **2** for **Program**, but any Pocket and Program combination can be entered, including those defining 'virtual' sweep programs. For a definition of 'virtual' sweep programs, see section 5.6.4

Figure 5-20 Save Target Popup After User Enters 3 for Pocket and 2 for Program

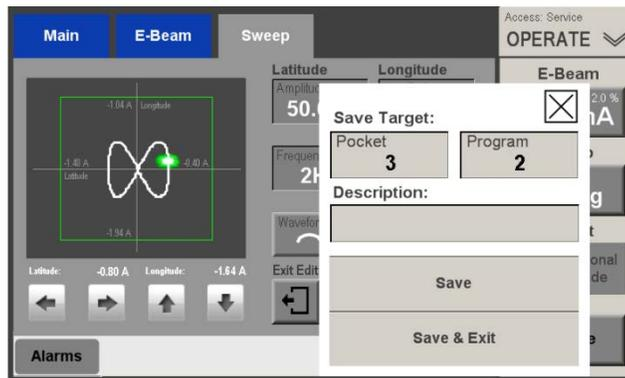

- 8 When the desired Target is defined in the popup, touch the **Save Exit** button. After you do so, the Operations>Sweep screen will again display the sweep program which was displayed when this procedure began. In this example, the screen would again appear as shown in Figure 5-14.

5.6.4 Making Multiple Backup Copies of a Sweep Pattern

'Virtual' Pocket Defined

The Genius II makes it possible to create one or more backup copies of a sweep pattern to 'virtual' Pocket/Program targets without exiting from sweep-edit mode. To do so, simply use the **Load Edit** button and the **Load Location** popup to save a sweep pattern to Program 1-10 of any pocket for which your Genius II is *not* configured. For example, if your system's e-

gun has 6 pockets, you can save sweep patterns to Programs 1-10 of Pockets 7-10, yielding a capacity of 40 'virtual' sweep programs. You can later use the **Load Edit** button to call up a virtual program in sweep-edit mode and then assign it an operational Pocket and Program number.

Procedure for Making 'Virtual' Backup Copies of a Sweep Program

To create one or more 'virtual' copies of a given sweep program, perform the procedure described below.

| Step | Action |
|------|--|
| 1 | Select the sweep program that you want to copy multiple times. If desired, perform a procedure similar that described above to modify the sweep pattern. |
| 2 | Touch the Save button to display the Save Target popup, which will appear similar that shown in Figure 5-13, but displaying with the Pocket and Program numbers of the program you wish to copy. |
| 3 | Change the numbers in the popup's Pocket and Program boxes to that of the target 'virtual' program. |
| 4 | Touch the popup's Save button. Doing this saves the sweep pattern to the target defined in the Pocket and Program boxes. |
| 5 | Repeat Steps 3 and 4 as many times as desired. In each iteration, enter a Program number between 11 and 99 to create another virtual sweep program. |
| 6 | When you have created all the copies you wish to make of this sweep pattern, touch the popup's Save & Exit button. Only then will the unit exit from sweep-edit mode. |

The screen will then appear as it did at the beginning of this procedure, with the initial Pocket and Program numbers displayed and that program's parameters displayed without alteration.

5.6.5 Importing and Modifying Sweep Patterns with Arbitrary Waveforms

The Genius II enables you to import a selected Arbitrary waveform and apply it to a given sweep program. Arbitrary waveforms can be imported only from a flash memory device or from an external hard drive connected to the Genius II via one of its two front-panel USB ports.

Note that once you have selected an Arbitrary waveform, you can change both the Latitudinal and Longitudinal Amplitude values but only the Latitudinal Frequency value (see Figure 5-22).

Perform the following procedure to import a sweep pattern with an Arbitrary waveform.

| Step | Action |
|------|--|
| 1 | Make sure that a flash memory device or an external hard drive is connected to one of the Genius II's front-panel USB ports. |

- 2 Open the Operations>Sweep screen with any sweep program displayed.

Figure 5-21 Ops>Sweep Screen with Sine Waveform Sweep Pattern Selected

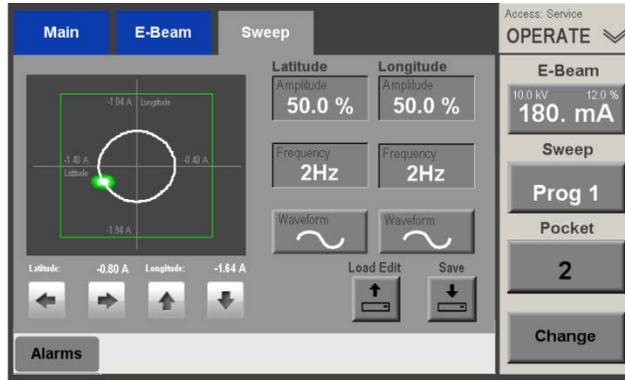

- 3 Touch the screen's Latitude **Waveform** button repeatedly until the legend **Arbitrary** appears on that button. The screen will then appear as shown in Figure 5-22.

NOTE

You can also change the waveform via the hand-held remote controller by selecting Menu 2 and pressing the **Wave Select** button (see Figure 5-29). However, if you do so, you will still have to use the Ops>Sweep screen's **Import** button to select and import the desired arbitrary waveform.

Figure 5-22 Ops>Sweep Screen After Arbitrary Waveform Is Selected



- 4 Touch the screen's **Import** button to display the dialog box shown in Figure 5-23.

Figure 5-23 Select File Dialog Box for Arbitrary Waveforms When Initially Displayed

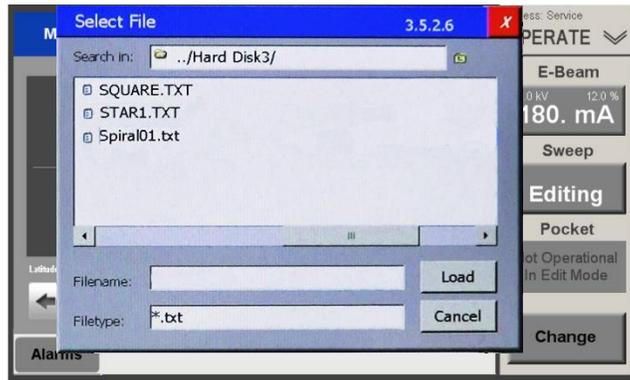

- 5 Select the filename of the arbitrary pattern you wish to import. In Figure 5-24 the user has selected *Spiral01.txt*.

Figure 5-24 Select File Dialog Box, User Has Selected *Spiral01.txt*

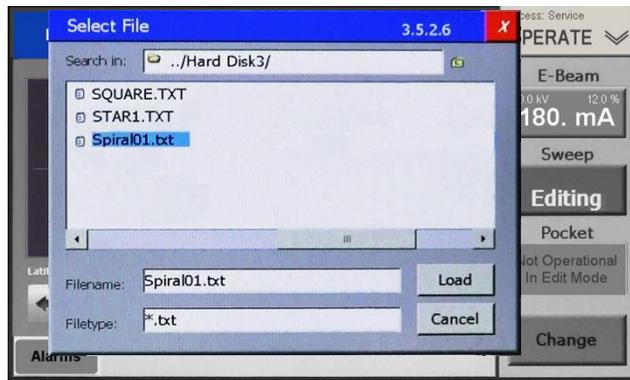

- 6 Touch the popup's **Load** button to close the popup and load the selected file. The screen will then appear to that shown in Figure 5-25.

Figure 5-25 Ops>Sweep Screen, in Edit Mode, Displaying Spiral01 Arbitrary Waveform

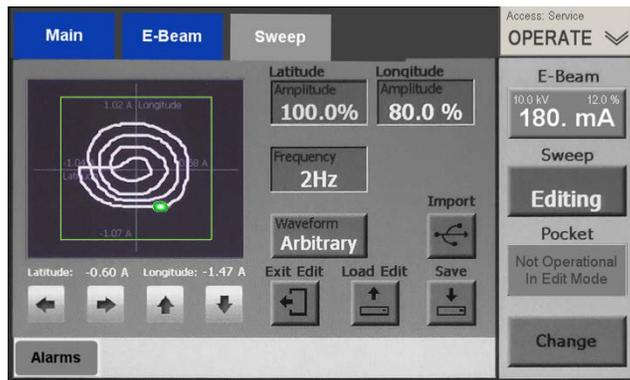

- 7 Modify the pattern's sweep parameters as desired.
- 8 Touch the screen's **Save** button. The screen will then display a **Save Target** popup with the Pocket and Program numbers of the original sweep program, as shown in Figure 5-26.

Figure 5-26 Save Target Popup Displaying Pocket and Program Numbers of Program Displayed at Beginning of Procedure

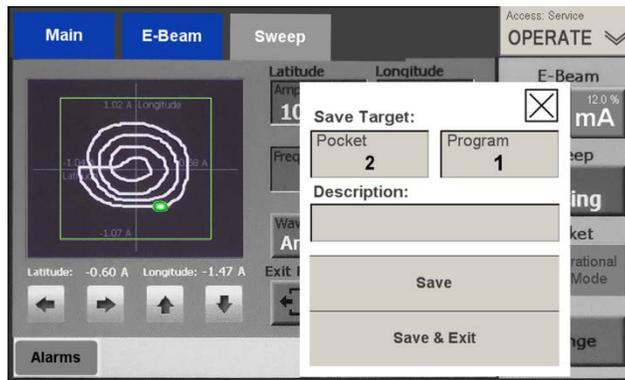

- 9 If you wish to overwrite the original sweep pattern with the new arbitrary sweep pattern, simply touch the popup's **Save & Exit** button. If you wish to save this arbitrary pattern to some other target Pocket and Program, enter the desired numbers in the popup's **Pocket** and/or **Program** boxes and then touch the **Save & Exit** button. Figure 5-27 shows the screen after the user has touched **Save & Exit** with Pocket 2 and Program 1 selected in the **Save Target** popup.

Figure 5-27 Spiral01 Arbitrary Waveform Saved as Program 1 of Pocket 2

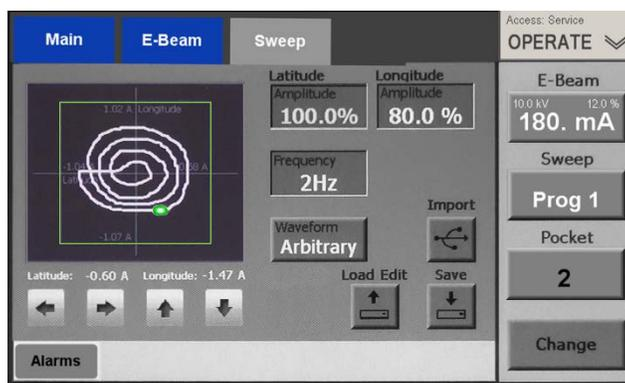

Note that you can also save one or more backup copies of this program to 'virtual' program(s). To do so, perform Steps 3-5 of the procedure described in section 5.6.4 before touching the **Save & Exit** button.

5.7 Genius II Operation from the Hand-Held Remote Controller

5.7.1 Control Functions Available Via the Remote Controller when the Genius II Is In Operations Mode

When the E-Beam and Sweep controls modules are both configured as **Local** and the unit is in Operations mode, the following functions can be controlled from the hand-held remote controller:

- E-beam on/off
- E-beam power level (0-100%)
- E-beam position
- Sweep enable/disable
- Turret rotation to next pocket in ascending order
- Configuration of sweep parameters (amplitude, frequency, and waveform)

The remote controller makes these functions available via two different screen menus, which are shown in Figures 5-29 and 5-30.

5.7.2 Control Functions Available Via Menu 1

Figure 5-28 shows the remote controller in Operations mode with Menu 1 displayed. Menu 1 enables the user to switch the beam and the sweep on and off, to adjust the percentage of e-beam power when the beam is on, and to adjust the position of the beam in both the *X* and *Y* axes. Note that users wishing to switch the gun and HV on/off independently of each other must do so via the main UI's Ops>E-Beam screen.

Figure 5-28 Remote Controller Screen in Ops Mode, Menu 1 Selected, Beam and Sweep Off



5.7.3 Control Functions Available Via Menu 2

Figure 5-29 shows the remote controller in Operations mode, with Menu 2 displayed and the beam switched off. Menu 2 enables the user to rotate the turret to the next pocket in ascending order and to alter sweep program parameters (amplitude, frequency, and waveform). Note that changes made to sweep program parameters affect both the X - and Y -axis parameters. Users wishing to change either an X -axis or a Y -axis parameter independently must do so from the main UI's Ops>Sweep screen. Likewise, sweep program selection can be done only from that screen. Turret rotation to any pocket other than the next pocket in ascending order must be commanded from the main UI screen.

Figure 5-29 Remote Controller Screen in Ops Mode, Menu 2 Selected, Beam and Sweep On

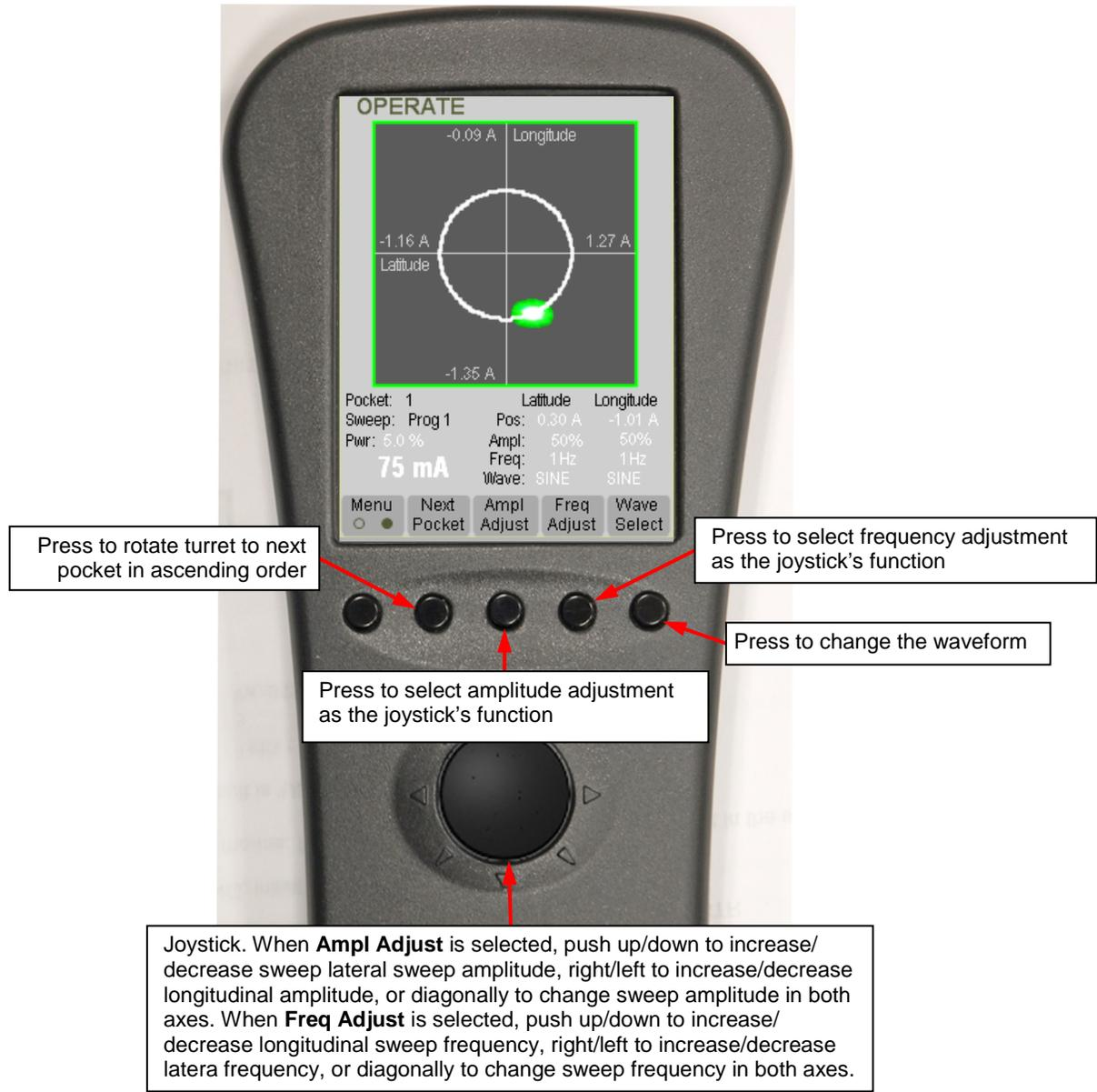

6 *Genius II Operation with a Deposition Controller*

6.1 Section Overview

This section describes how to operate the Genius II in conjunction with either a single-layer or a multilayer deposition controller in a system that is not controlled by a PLC-based system controller.

Section 6.2 Genius II Operation with a Single-Layer Deposition Controller

Section 6.2.1 Modification to Configuration Procedure

Section 6.2.2 General Operating Methods

Section 6.2.3 Executing a Film Deposition

Section 6.2.1 Genius II Operation with a Multilayer Deposition Controller

Section 6.3.1 Modification to Configuration Procedure

Section 6.3.2 General Operational Methods

Section 6.3.3 Reprogramming the Deposition Controller's I/Os

Section 6.3.4 Executing a Deposition Process

NOTE

When all control modules are configured as **Remote I/O**, **EtherCAT**, or **RS232**, operation in Manual mode is identical to operation in Operations mode when all control modules are configured as **Local**.

6.2 Genius II Operation with a Single-Layer Deposition Controller

6.2.1 Modification to Configuration Procedure

Genius II configuration for use with a single-layer deposition controller is identical to the configuration procedure described in Section 3 of this manual, with one exception: In Step 3 of section 3.4, you must select **External** for **Emis Control**.

6.2.2 General Operating Methods

When the Genius II is configured as described in section 6.2.1, all Genius II screens appear as shown in section 1.5, except that on Operations mode screens, the **E-Beam** button on the Command Button Bar becomes a flat value-display rectangle like that shown in Figure 6-1.

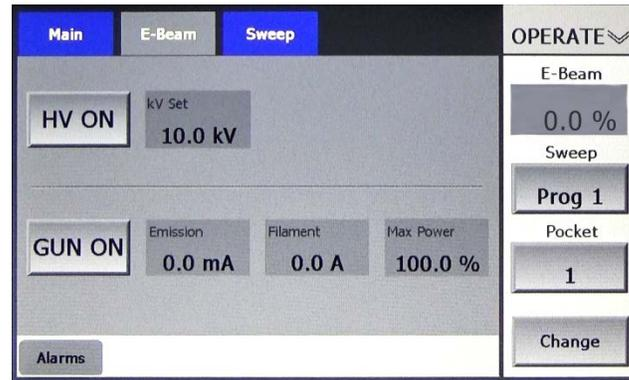
Figure 6-1 Operations E-Beam Screen when *External* Is Selected for *Emis Control*

General operating methods are as described in Section 4, except that the user cannot use the **E-Beam** button on the command button bar to switch the beam on/off or to or to set the emission power level. Nor is it possible to perform either operation from the hand-held remote controller.

The user also has the option of temporarily putting the Genius II into Manual Mode, which provides full E-Beam control from the Manual mode's E-Beam screen. This mode of operation is generally used for predeposition evaporant conditioning. For complete information about Manual mode operation, see section 1.5.3.

6.2.3 Executing a Film Deposition

To perform a film deposition using the Genius II in conjunction with the deposition controller, follow the procedure described below. This procedure assumes that the Genius II and the deposition controller are both installed correctly and powered up, that the Genius II is configured as described in section 6.2.1, and that the deposition controller has the desired film layer properly programmed and selected for execution.

| Step | Action |
|------|--|
| 1 | Display the Operations>E-Beam screen, if it is not already displayed. |
| 2 | Use the Pocket button on the Command Button Bar to select the pocket desired for the film layer you are about to deposit. |
| 3 | Using the Command Button Bar's Sweep button, select the sweep program desired for this film layer. |
| 4 | Use the HV ON and GUN ON buttons to switch on the HV and the gun. |
| 5 | Make sure the deposition controller is in READY or IDLE mode. |
| 6 | Press the START button on the deposition controller front panel. |

6.3 Genius II Operation with a Multilayer Deposition Controller

6.3.1 Modification to Configuration Procedure

To configure the Genius II for use with a multilayer deposition, perform the procedure described below.

| Step | Action |
|------|---|
| 1 | Perform the procedure described in section 3.2, configuring all control modules as Remote I/O . |
| 2 | Perform the procedures described in sections 3.3 |
| 3 | Configure the e-beam control module. First perform Steps 1 and 2 of the procedure described in section 3.4. |
| 4 | In Step 3, select External for Emis Control . |
| 5 | Perform Steps 4 and 5 of that procedure as written. |
| 6 | Perform the procedure described in section 3.5 to configure the turret control module. |
| 7 | Display the Config>Sweep screen and make sure that Enabled is selected for Operate Modify . Change that screen's default parameters as necessary (see section 3.6). |
| 8 | Perform the procedure described in section 3.7 to configure profiles. |
| 9 | Perform the procedures described in sections 3.8 and 3.9 as needed. |
| 10 | Perform the procedure described in section 3.10. |

6.3.2 General Operational Methods

Appearance of UI Screens in this Configuration Mode

When the Genius II is configured as described in section 6.3.1, the Operations mode screens appear as shown in Figure 6-2. Configuration mode screens appear as shown in Figure 1-7, and Service mode screens appear as shown in Figure 1-12.

Figure 6-2 Appearance of Operations Mode Screens when All Control Modules Are Configured as Remote I/O

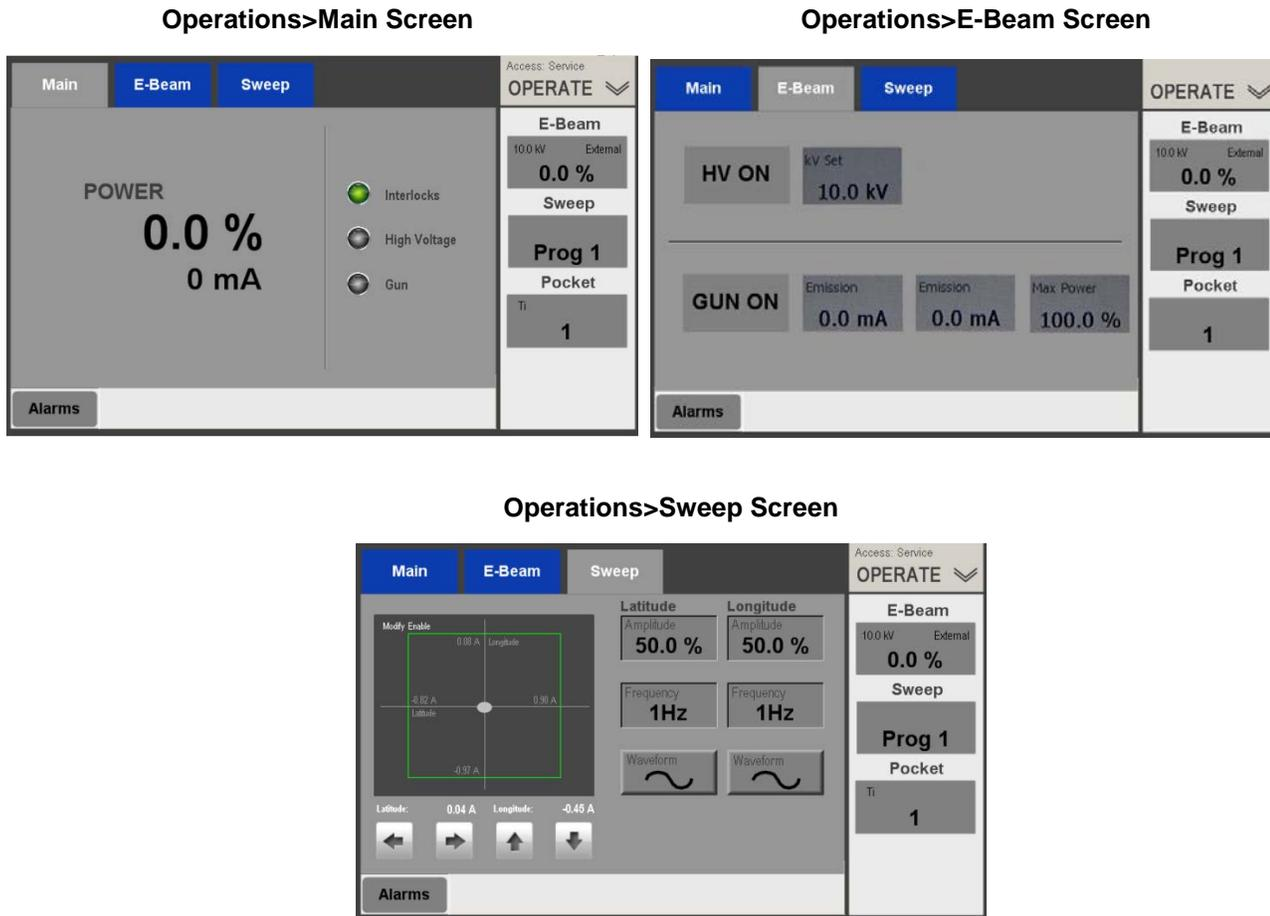

Local Mode Operations Available in this Configuration Mode

When Genius II is configured as described in section 6.3.1, the only operations that can be performed from Operations mode screens is modification of the sweep program that is currently selected, as described in section 5.6.2. In Configuration mode, the Genius II operates as described in Section 3; in Service mode, it operates as described in Section 8. When the Genius II is in Configuration mode, the user can employ the **kV Set** button on Profiles Page 1 to adjust the HV output of the HVPS.

The user also has the option of temporarily putting the Genius II into Manual Mode, which provides full E-Beam control from the Manual mode's E-Beam screen. This mode of operation is generally used for predeposition evaporant conditioning. For complete information about Manual mode operation, see section 1.5.3.

6.3.3 Reprogramming the Deposition Controller's I/Os

The deposition controller must provide outputs that will:

1. supply the **BEAM ON** and **BEAM OFF** output to Pins A5 and A6 on Genius II rear panel connector X110 (see Figure 2-5 and Table 2-1), and
2. supply the data-set-selection bits required by the Genius II.

In addition, the **POCKET GOOD** signal output from Pin 1 on Genius II rear panel connector X119 (see Figure 2-7) must be supplied to the deposition controller.

For information on implementing Item #1 above, see Table 2-1 and Figures 2-5 and 2-6. For some deposition controllers, implementing Items #2 above and implementing the **POCKET GOOD** signal may entail reprogramming some of the deposition controller's outputs. The following procedure describes how this can be achieved if your system's deposition controller is the Inficon XTC/3M.

| Step | Action |
|------|--|
| 1 | Following the instructions in section 4.5 of the XTC/3 manual, program TTL outputs 1-6 to output one of the data sets shown in either Table 6-1, 6-2, or 6-3, depending on whether your Genius II is controlling a four-, six-, or eight-pocket source. Those outputs (Pins 18-23 on XTC/3M rear panel connector) would then be connected to Pins A1-A6 on Genius II rear panel connector X119 (see Figure 2-7 of this manual), supplying the required date-set-selection bits. Depending on the voltages and polarity of these TTL outputs, it may be necessary to interpose relays between them and Inputs A1-A6 on Genius II rear panel connector X119. Within the Genius II, these data sets select the pocket and sweep program numbers or each film layer. |
| 2 | To Input 1 (Pin 1 on the XTC/3M rear panel Sys I/O connector), assign the function Cruc 1 Valid . That pin would then be connected to Pin B1 on Genius II rear panel connector X119, which outputs the POCKET GOOD signal (see Figure 2-7 of this manual). |

Table 6-1 Data Set Selection BCD Codes for a Four-Pocket Source

| Input Pin Number | | | | | | Data Set Selected | Pocket Number Selected | Sweep Program Selected |
|------------------|----|----|----|----|----|-------------------|------------------------|------------------------|
| A6 | A5 | A4 | A3 | A2 | A1 | | | |
| 0 | 0 | 0 | 0 | 0 | 0 | 0 | 1 | 1 |
| 0 | 0 | 0 | 0 | 0 | 1 | 1 | 2 | 1 |
| 0 | 0 | 0 | 0 | 1 | 0 | 2 | 3 | 1 |
| 0 | 0 | 0 | 0 | 1 | 1 | 3 | 4 | 1 |
| 0 | 0 | 0 | 1 | 0 | 0 | 4 | 1 | 2 |
| 0 | 0 | 0 | 1 | 0 | 1 | 5 | 2 | 2 |
| 0 | 0 | 0 | 1 | 1 | 0 | 6 | 3 | 2 |
| 0 | 0 | 0 | 1 | 1 | 1 | 7 | 4 | 2 |
| 0 | 0 | 1 | 0 | 0 | 0 | 8 | 1 | 3 |
| 0 | 0 | 1 | 0 | 0 | 1 | 9 | 2 | 3 |
| 0 | 0 | 1 | 0 | 1 | 0 | 10 | 3 | 3 |
| 0 | 0 | 1 | 0 | 1 | 1 | 11 | 4 | 3 |
| 0 | 0 | 1 | 1 | 0 | 0 | 12 | 1 | 4 |
| 0 | 0 | 1 | 1 | 0 | 1 | 13 | 2 | 4 |
| 0 | 0 | 1 | 1 | 1 | 0 | 14 | 3 | 4 |
| 0 | 0 | 1 | 1 | 1 | 1 | 15 | 4 | 4 |
| 0 | 1 | 0 | 0 | 0 | 0 | 16 | 1 | 5 |
| 0 | 1 | 0 | 0 | 0 | 1 | 17 | 2 | 5 |
| 0 | 1 | 0 | 0 | 1 | 0 | 18 | 3 | 5 |
| 0 | 1 | 0 | 0 | 1 | 1 | 19 | 4 | 5 |
| 0 | 1 | 0 | 1 | 0 | 0 | 20 | 1 | 6 |
| 0 | 1 | 0 | 1 | 0 | 1 | 21 | 2 | 6 |
| 0 | 1 | 0 | 1 | 1 | 0 | 22 | 3 | 6 |
| 0 | 1 | 0 | 1 | 1 | 1 | 23 | 4 | 6 |
| 0 | 1 | 1 | 0 | 0 | 0 | 24 | 1 | 7 |
| 0 | 1 | 1 | 0 | 0 | 1 | 25 | 2 | 7 |
| 0 | 1 | 1 | 0 | 1 | 0 | 26 | 3 | 7 |
| 0 | 1 | 1 | 0 | 1 | 1 | 27 | 4 | 7 |
| 0 | 1 | 1 | 1 | 0 | 0 | 28 | 1 | 8 |
| 0 | 1 | 1 | 1 | 0 | 1 | 29 | 2 | 8 |
| 0 | 1 | 1 | 1 | 1 | 0 | 30 | 3 | 8 |
| 0 | 1 | 1 | 1 | 1 | 1 | 31 | 4 | 8 |
| 1 | 0 | 0 | 0 | 0 | 0 | 32 | 1 | 9 |
| 1 | 0 | 0 | 0 | 0 | 1 | 33 | 2 | 9 |
| 1 | 0 | 0 | 0 | 1 | 0 | 34 | 3 | 9 |
| 1 | 0 | 0 | 0 | 1 | 1 | 35 | 4 | 9 |
| 1 | 0 | 0 | 1 | 0 | 0 | 36 | 1 | 10 |
| 1 | 0 | 0 | 1 | 0 | 1 | 37 | 2 | 10 |
| 1 | 0 | 0 | 1 | 1 | 0 | 38 | 3 | 10 |
| 1 | 0 | 0 | 1 | 1 | 1 | 39 | 4 | 10 |

Table 6-2 Data Set Selection BCD Codes for a Six-Pocket Source

| Input Pin Number | | | | | | Data Set Selected | Pocket Number Selected | Sweep Program Selected |
|------------------|----|----|----|----|----|-------------------|------------------------|------------------------|
| A6 | A5 | A4 | A3 | A2 | A1 | | | |
| 0 | 0 | 0 | 0 | 0 | 0 | 0 | 1 | 1 |
| 0 | 0 | 0 | 0 | 0 | 1 | 1 | 2 | 1 |
| 0 | 0 | 0 | 0 | 1 | 0 | 2 | 3 | 1 |
| 0 | 0 | 0 | 0 | 1 | 1 | 3 | 4 | 1 |
| 0 | 0 | 0 | 1 | 0 | 0 | 4 | 5 | 1 |
| 0 | 0 | 0 | 1 | 0 | 1 | 5 | 6 | 1 |
| 0 | 0 | 0 | 1 | 1 | 0 | 6 | 1 | 2 |
| 0 | 0 | 0 | 1 | 1 | 1 | 7 | 2 | 2 |
| 0 | 0 | 1 | 0 | 0 | 0 | 8 | 3 | 2 |
| 0 | 0 | 1 | 0 | 0 | 1 | 9 | 4 | 2 |
| 0 | 0 | 1 | 0 | 1 | 0 | 10 | 5 | 2 |
| 0 | 0 | 1 | 0 | 1 | 1 | 11 | 6 | 2 |
| 0 | 0 | 1 | 1 | 0 | 0 | 12 | 1 | 3 |
| 0 | 0 | 1 | 1 | 0 | 1 | 13 | 2 | 3 |
| 0 | 0 | 1 | 1 | 1 | 0 | 14 | 3 | 3 |
| 0 | 0 | 1 | 1 | 1 | 1 | 15 | 4 | 3 |
| 0 | 1 | 0 | 0 | 0 | 0 | 16 | 5 | 3 |
| 0 | 1 | 0 | 0 | 0 | 1 | 17 | 6 | 3 |
| 0 | 1 | 0 | 0 | 1 | 0 | 18 | 1 | 4 |
| 0 | 1 | 0 | 0 | 1 | 1 | 19 | 2 | 4 |
| 0 | 1 | 0 | 1 | 0 | 0 | 20 | 3 | 4 |
| 0 | 1 | 0 | 1 | 0 | 1 | 21 | 4 | 4 |
| 0 | 1 | 0 | 1 | 1 | 0 | 22 | 5 | 4 |
| 0 | 1 | 0 | 1 | 1 | 1 | 23 | 6 | 4 |
| 0 | 1 | 1 | 0 | 0 | 0 | 24 | 1 | 5 |
| 0 | 1 | 1 | 0 | 0 | 1 | 25 | 2 | 5 |
| 0 | 1 | 1 | 0 | 1 | 0 | 26 | 3 | 5 |
| 0 | 1 | 1 | 0 | 1 | 1 | 27 | 4 | 5 |
| 0 | 1 | 1 | 1 | 0 | 0 | 28 | 5 | 5 |
| 0 | 1 | 1 | 1 | 0 | 1 | 29 | 6 | 5 |
| 0 | 1 | 1 | 1 | 1 | 0 | 30 | 1 | 6 |
| 0 | 1 | 1 | 1 | 1 | 1 | 31 | 2 | 6 |
| 1 | 0 | 0 | 0 | 0 | 0 | 32 | 3 | 6 |
| 1 | 0 | 0 | 0 | 0 | 1 | 33 | 4 | 6 |
| 1 | 0 | 0 | 0 | 1 | 0 | 34 | 5 | 6 |
| 1 | 0 | 0 | 0 | 1 | 1 | 35 | 6 | 6 |
| 1 | 0 | 0 | 1 | 0 | 0 | 36 | 1 | 7 |
| 1 | 0 | 0 | 1 | 0 | 1 | 37 | 2 | 7 |
| 1 | 0 | 0 | 1 | 1 | 0 | 38 | 3 | 7 |
| 1 | 0 | 0 | 1 | 1 | 1 | 39 | 4 | 7 |
| 1 | 0 | 1 | 0 | 0 | 0 | 40 | 5 | 7 |
| 1 | 0 | 1 | 0 | 0 | 1 | 41 | 6 | 7 |
| 1 | 0 | 1 | 0 | 1 | 0 | 42 | 1 | 8 |
| 1 | 0 | 1 | 0 | 1 | 1 | 43 | 2 | 8 |
| 1 | 0 | 1 | 1 | 0 | 0 | 44 | 3 | 8 |
| 1 | 0 | 1 | 1 | 0 | 1 | 45 | 4 | 8 |
| 1 | 0 | 1 | 1 | 1 | 0 | 46 | 5 | 8 |
| 1 | 0 | 1 | 1 | 1 | 1 | 47 | 6 | 8 |
| 1 | 1 | 0 | 0 | 0 | 0 | 48 | 1 | 9 |
| 1 | 1 | 0 | 0 | 0 | 1 | 49 | 2 | 9 |
| 1 | 1 | 0 | 0 | 1 | 0 | 50 | 3 | 9 |
| 1 | 1 | 0 | 0 | 1 | 1 | 51 | 4 | 9 |
| 1 | 1 | 0 | 1 | 0 | 0 | 52 | 5 | 9 |
| 1 | 1 | 0 | 1 | 0 | 1 | 53 | 6 | 9 |
| 1 | 1 | 0 | 1 | 1 | 0 | 54 | 1 | 10 |
| 1 | 1 | 0 | 1 | 1 | 1 | 55 | 2 | 10 |
| 1 | 1 | 1 | 0 | 0 | 0 | 56 | 3 | 10 |
| 1 | 1 | 1 | 0 | 0 | 1 | 57 | 4 | 10 |
| 1 | 1 | 1 | 0 | 1 | 0 | 58 | 5 | 10 |
| 1 | 1 | 1 | 0 | 1 | 1 | 59 | 6 | 10 |

Table 6-3 Data Set Selection BCD Codes for an Eight-Pocket Source

| Input Pin Number | | | | | | Data Set Selected | Pocket Number Selected | Sweep Program Selected |
|------------------|----|----|----|----|----|-------------------|------------------------|------------------------|
| A6 | A5 | A4 | A3 | A2 | A1 | | | |
| 0 | 0 | 0 | 0 | 0 | 0 | 0 | 1 | 1 |
| 0 | 0 | 0 | 0 | 0 | 1 | 1 | 2 | 1 |
| 0 | 0 | 0 | 0 | 1 | 0 | 2 | 3 | 1 |
| 0 | 0 | 0 | 0 | 1 | 1 | 3 | 4 | 1 |
| 0 | 0 | 0 | 1 | 0 | 0 | 4 | 5 | 1 |
| 0 | 0 | 0 | 1 | 0 | 1 | 5 | 6 | 1 |
| 0 | 0 | 0 | 1 | 1 | 0 | 6 | 7 | 1 |
| 0 | 0 | 0 | 1 | 1 | 1 | 7 | 8 | 1 |
| 0 | 0 | 1 | 0 | 0 | 0 | 8 | 1 | 2 |
| 0 | 0 | 1 | 0 | 0 | 1 | 9 | 2 | 2 |
| 0 | 0 | 1 | 0 | 1 | 0 | 10 | 3 | 2 |
| 0 | 0 | 1 | 0 | 1 | 1 | 11 | 4 | 2 |
| 0 | 0 | 1 | 1 | 0 | 0 | 12 | 5 | 2 |
| 0 | 0 | 1 | 1 | 0 | 1 | 13 | 6 | 2 |
| 0 | 0 | 1 | 1 | 1 | 0 | 14 | 7 | 2 |
| 0 | 0 | 1 | 1 | 1 | 1 | 15 | 8 | 2 |
| 0 | 1 | 0 | 0 | 0 | 0 | 16 | 1 | 3 |
| 0 | 1 | 0 | 0 | 0 | 1 | 17 | 2 | 3 |
| 0 | 1 | 0 | 0 | 1 | 0 | 18 | 3 | 3 |
| 0 | 1 | 0 | 0 | 1 | 1 | 19 | 4 | 3 |
| 0 | 1 | 0 | 1 | 0 | 0 | 20 | 5 | 3 |
| 0 | 1 | 0 | 1 | 0 | 1 | 21 | 6 | 3 |
| 0 | 1 | 0 | 1 | 1 | 0 | 22 | 7 | 3 |
| 0 | 1 | 0 | 1 | 1 | 1 | 23 | 8 | 3 |
| 0 | 1 | 1 | 0 | 0 | 0 | 24 | 1 | 4 |
| 0 | 1 | 1 | 0 | 0 | 1 | 25 | 2 | 4 |
| 0 | 1 | 1 | 0 | 1 | 0 | 26 | 3 | 4 |
| 0 | 1 | 1 | 0 | 1 | 1 | 27 | 4 | 4 |
| 0 | 1 | 1 | 1 | 0 | 0 | 28 | 5 | 4 |
| 0 | 1 | 1 | 1 | 0 | 1 | 29 | 6 | 4 |
| 0 | 1 | 1 | 1 | 1 | 0 | 30 | 7 | 4 |
| 0 | 1 | 1 | 1 | 1 | 1 | 31 | 8 | 4 |
| 1 | 0 | 0 | 0 | 0 | 0 | 32 | 1 | 5 |
| 1 | 0 | 0 | 0 | 0 | 1 | 33 | 2 | 5 |
| 1 | 0 | 0 | 0 | 1 | 0 | 34 | 3 | 5 |
| 1 | 0 | 0 | 0 | 1 | 1 | 35 | 4 | 5 |
| 1 | 0 | 0 | 1 | 0 | 0 | 36 | 5 | 5 |
| 1 | 0 | 0 | 1 | 0 | 1 | 37 | 6 | 5 |
| 1 | 0 | 0 | 1 | 1 | 0 | 38 | 7 | 5 |
| 1 | 0 | 0 | 1 | 1 | 1 | 39 | 8 | 5 |
| 1 | 0 | 1 | 0 | 0 | 0 | 40 | 1 | 6 |
| 1 | 0 | 1 | 0 | 0 | 1 | 41 | 2 | 6 |
| 1 | 0 | 1 | 0 | 1 | 0 | 42 | 3 | 6 |
| 1 | 0 | 1 | 0 | 1 | 1 | 43 | 4 | 6 |
| 1 | 0 | 1 | 1 | 0 | 0 | 44 | 5 | 6 |
| 1 | 0 | 1 | 1 | 0 | 1 | 45 | 6 | 6 |
| 1 | 0 | 1 | 1 | 1 | 0 | 46 | 7 | 6 |
| 1 | 0 | 1 | 1 | 1 | 1 | 47 | 8 | 6 |
| 1 | 1 | 0 | 0 | 0 | 0 | 48 | 1 | 7 |
| 1 | 1 | 0 | 0 | 0 | 1 | 49 | 2 | 7 |
| 1 | 1 | 0 | 0 | 1 | 0 | 50 | 3 | 7 |
| 1 | 1 | 0 | 0 | 1 | 1 | 51 | 4 | 7 |
| 1 | 1 | 0 | 1 | 0 | 0 | 52 | 5 | 7 |
| 1 | 1 | 0 | 1 | 0 | 1 | 53 | 6 | 7 |
| 1 | 1 | 0 | 1 | 1 | 0 | 54 | 7 | 7 |
| 1 | 1 | 0 | 1 | 1 | 1 | 55 | 8 | 7 |
| 1 | 1 | 1 | 0 | 0 | 0 | 56 | 1 | 8 |
| 1 | 1 | 1 | 0 | 0 | 1 | 57 | 2 | 8 |
| 1 | 1 | 1 | 0 | 1 | 0 | 58 | 3 | 8 |
| 1 | 1 | 1 | 0 | 1 | 1 | 59 | 4 | 8 |
| 1 | 1 | 1 | 1 | 0 | 0 | 60 | 5 | 8 |

| Input Pin Number | | | | | | Data Set Selected | Pocket Number Selected | Sweep Program Selected |
|------------------|----|----|----|----|----|-------------------|------------------------|------------------------|
| A6 | A5 | A4 | A3 | A2 | A1 | | | |
| 1 | 1 | 1 | 1 | 0 | 1 | 61 | 6 | 8 |
| 1 | 1 | 1 | 1 | 1 | 0 | 62 | 7 | 8 |
| 1 | 1 | 1 | 1 | 1 | 1 | 63 | 8 | 8 |

6.3.4 Executing a Deposition Process

To perform a multifilm deposition process using the Genius II in conjunction with a multilayer deposition controller, follow the procedure described below. This procedure assumes that the Genius II and the deposition controller are both installed and configured correctly and are both powered up.

| Step | Action |
|------|---|
| 1 | Using the controls on the deposition controller's front panel, program the film process to be executed. |
| 2 | Put the deposition controller into either its READY mode or its IDLE mode. |
| 3 | Display the Genius II's Operations>Sweep screen, if it is not already displayed. |
| 4 | Press the START button on the deposition controller's front panel. |

7 Genius II Operation With a PLC-Based System Controller

7.1 Section Overview

This section describes the configuration and operation of the Genius II when it is under the control of a PLC-based system controller such as the Temescal Control System (TCS). The subsections are:

- Section 7.2 Operation with All Control Modules Configured as *Remote I/O*
 - Section 7.2.1 Modifications to Hardware Cabling Procedure
 - Section 7.2.2 Modifications to Basic Configuration Procedures
 - Section 7.2.3 Appearance of Operations and Manual Mode Screens when all Control Modules Are Configured as Remote I/O
 - Section 7.2.4 Operations and Manual Mode Operation under Remote I/O Control
- Section 7.3 Implementing PLC Control via EtherCAT
 - Section 7.3.1 Modifications to Hardware Cabling Procedure
 - Section 7.3.2 Modifications to Basic Configuration Procedures
 - Section 7.3.3 Appearance of Operations and Manual Mode Screens when System Control via EtherCAT Is Implemented
 - Section 7.3.4 Operation in Operations and Manual Modes when Control Modules Are Configured as EtherCAT
- Section 7.4 Implementing PLC Control via RS-232
 - Section 7.4.1 Modifications to Hardware Cabling Procedure
 - Section 7.4.2 Modifications to Basic Configuration Procedures
 - Section 7.4.3 Appearance of Operations and Manual Mode Screens when System Control via RS-232 Is Implemented
 - Section 7.4.4 Operation in Operations and Manual Modes when Control Modules Are Configured as RS-232

NOTE

When all control modules are configured as **Remote I/O**, **EtherCAT**, or **RS232**, Genius II operation in Manual mode is identical to operation in Operations mode when all control modules are configured as **Local**.

7.2 Operation with All Control Modules Configured as *Remote I/O*

7.2.1 Modifications to Hardware Cabling Procedure

| Step | Action |
|------|--|
| 1 | Perform the procedure described in section 2.3.2 exactly as written. |
| 2 | Skip the instructions described in section 2.4.1. |
| 3 | When performing the procedure described in section 2.4.2, connect all non-interlock I/Os to the PLC. |
| 4 | Perform the procedure described in section 2.5. |

7.2.2 Modifications to Basic Configuration Procedures

To configure the Genius II to operate under the control of a PLC-based system controller, with all control modules configured as **Remote I/O**, perform the procedure described below.

- | Step | Action |
|------|---|
| 1 | When the Genius II is first booted up, the unit displays the boot-up screen shown in Figure 7-1. To put the unit into Configuration Mode, touch this screen's Configuration button. The unit will then display the Configuration>Main screen (see Figure 7-2). |

Figure 7-1 Genius II Boot-Up Screen

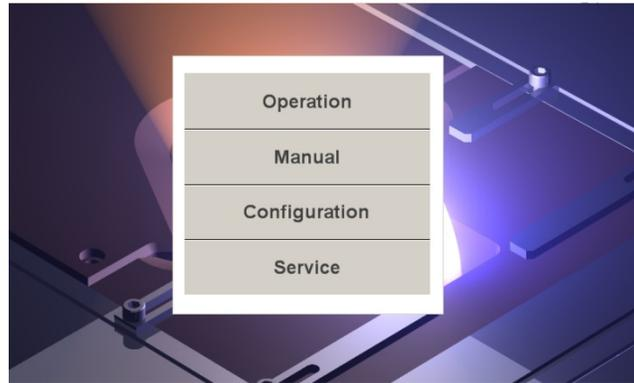
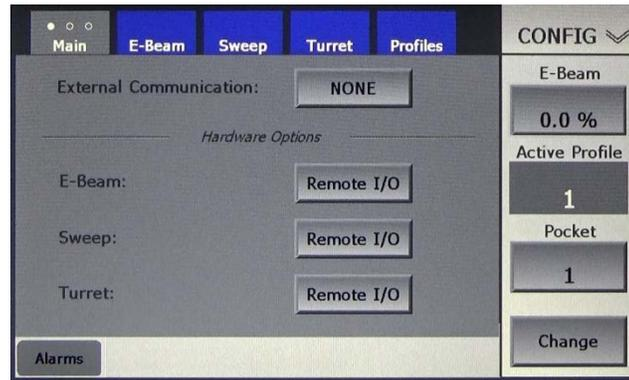

Figure 7-2 Config>Main Screen After Initial Boot-Up



- Perform the procedure described in section 3.2, selecting **NONE** for **External Communications** and configuring all three control modules as **Remote I/O**. The Config>Main screen will then appear as shown in Figure 7-3.

Figure 7-3 Configuration>Main Screen with All Control Modules Configured as Remote I/O



- 3 Set the system time and date, as described in section 3.3.
- 4 Perform Steps 1 and 2 of the procedure described in section 3.4.
- 5 In Step 3, select **External** for **Emis Control**.
- 6 Perform Steps 4 and 5 of that procedure as written.
- 7 Perform the procedure described in section 3.4.2 as needed.
- 8 Perform the procedures described in section 3.5 as written.
- 9 Adjust parameters on the Config>Sweep screen as necessary (see section 3.6 for parameter definitions). Select **Enabled** for **Operate Modify**.
- 10 Perform the procedure described in section 3.7 exactly as written.
- 11 Perform the procedures described in sections 3.8 and 3.9 as necessary/desired.
- 12 Perform the procedure described in section 3.10 to complete the configuration.

7.2.3 Appearance of Operations and Manual Mode Screens when all Control Modules Are Configured as *Remote I/O*

When all Genius II control modules are configured as **Remote I/O**, the unit's Operations mode screens appear as shown in Figure 7-4. Configuration mode screens appear as shown in Figure 1-7, and its Service mode screens appear as shown in Figure 1-12.

Figure 7-4 Appearance of Operations Mode Screens when the All Control Modules Are Configured as Remote I/O

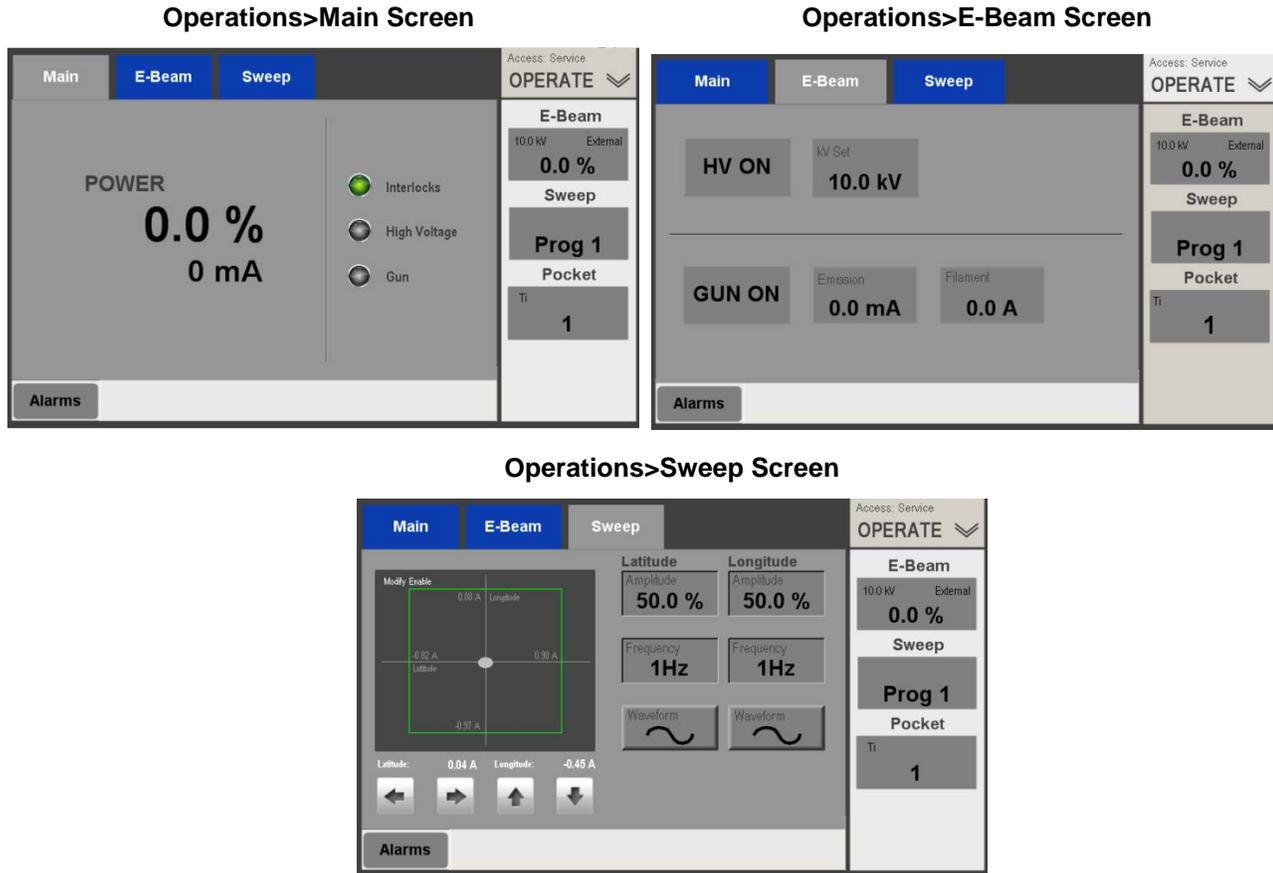

7.2.4 Operations and Manual Mode Operation under Remote I/O Control

When all three Genius II control modules are configured as **Remote I/O** and the non-interlock I/Os on connectors X110 and X119 are properly connected to the PCL, the Genius II is completely under the control of the PLC-based system controller and the deposition controller, except when the user puts the Genius II into Manual mode. Manual mode operation provides full control (including emission current control) from the Genius II screen. This mode of operation is generally used for predeposition evaporant conditioning.

7.3 Implementing PLC Control via EtherCAT

This section describes how to implement PLC control via EtherCAT communications and how the Genius II operates under those conditions.

NOTE
For information on gateway selection and memory mapping, see Appendix A.

7.3.1 Modifications to Hardware Cabling Procedure

| Step | Action |
|------|---|
| 1 | Perform the procedure described in section 2.3.2. |
| 2 | Connect the system network side of the AnyBus bridge to the PLC, and use an EtherCAT cable to connect the other side of the bridge to the ETHERCAT (RJ45) connector on the Genius II rear panel. |
| 3 | Perform the procedure described in section 2.4.1. |
| 4 | Perform the procedure described in section 2.5. |

7.3.2 Modifications to Basic Configuration Procedures

To configure the Genius II to operate under the control of a PLC-based system controller via EtherCAT, perform the procedure described below.

| Step | Action |
|------|---|
| 1 | Perform the procedure described in sections 3.2, selecting EtherCAT for External Communications . Doing this selects EtherCAT for all control modules. |
| 1 | If a given control module is not implemented in your Genius II, select Offline opposite that module's name. |
| 2 | Set the system time and date by performing the procedure described in section 3.3. |
| 3 | Perform Steps 1 and 2 of the procedure described in section 3.4.1. |
| 4 | Perform Steps 4 and 5 of that procedure as written. |
| 5 | If necessary, perform the procedure described in section 3.4.2 as needed. |
| 6 | Perform the procedures described in sections 3.5 exactly as written. |
| 7 | Adjust parameters on the Config>Sweep screen as necessary (see section 3.6 for parameter definitions). |
| 8 | Perform the procedures described in sections 3.7 exactly as written. |
| 9 | Perform the procedures described in sections 3.8 and 3.9 as needed/desired. |
| 10 | Complete the configuration by performing the procedure described in section 3.10. |
| 11 | Implement the memory mapping described in Appendix A. |

7.3.3 Appearance of Operations and Manual Mode Screens when System Control via EtherCAT Is Implemented

When **EtherCAT** is selected opposite **External Communications** on the Config>Main screen, the unit's Configuration mode screens appear as shown in Figure 1-7, its Service mode screens appear as shown in Figure 1-9, and its Operations mode screens appear as shown in Figure 7-5. When the Genius II is configured this way, the Manual mode screens are identical to the Operations mode screens, except that the mode ID/menu selection button on each screen is labeled **Manual** instead of **EtherCAT**.

Figure 7-5 Appearance of Operations Mode Screens when *EtherCAT* Is Selected for *External Communications*

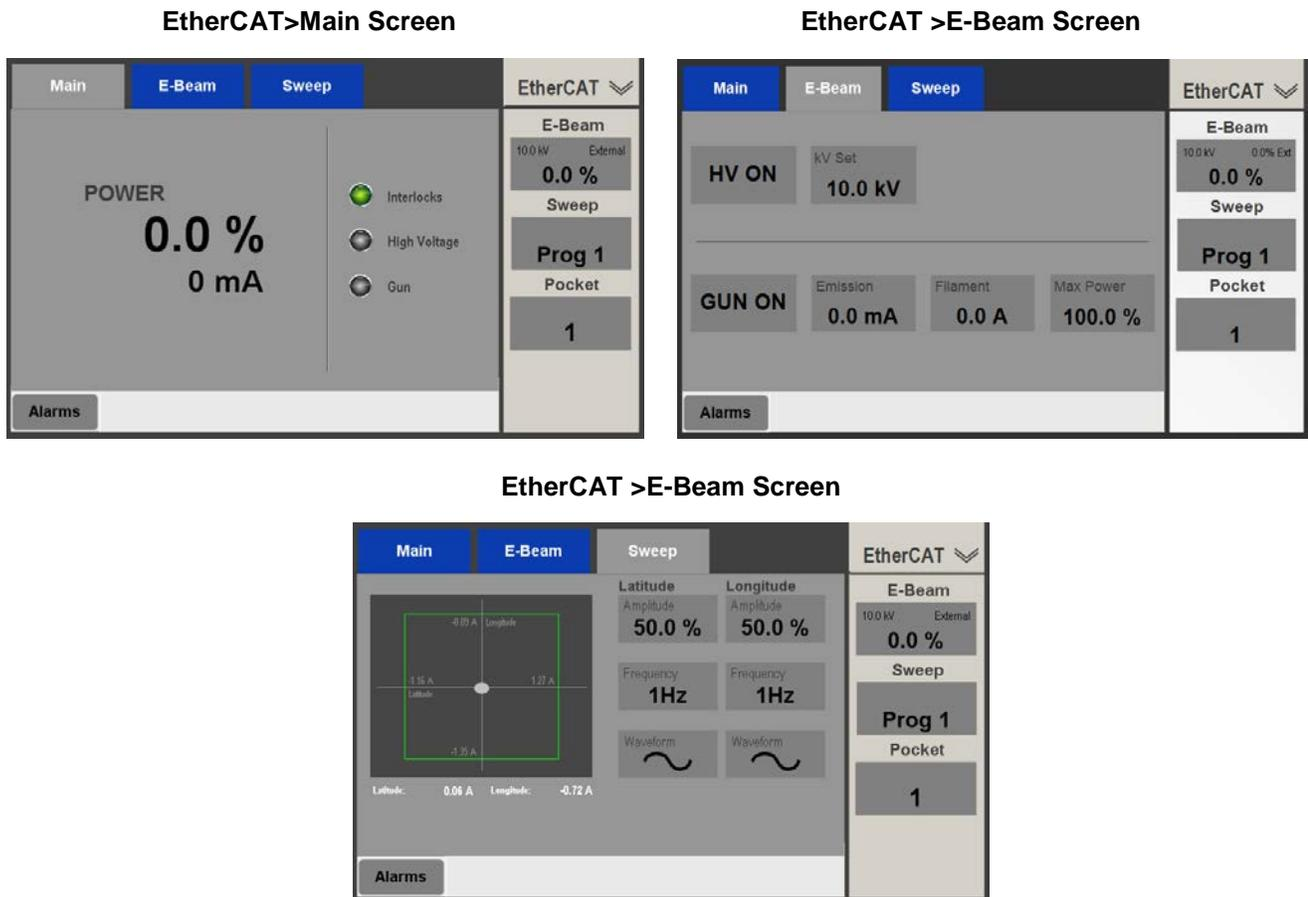

7.3.4 Operation in Operations and Manual Modes when Control Modules Are Configured as EtherCAT

When the Genius II's EtherCAT option is implemented, the unit is completely under the control of the PLC-based system controller and the deposition controller, except when:

- the unit is in Manual mode.
- the PLC-based system controller asserts the Modify Enable signal, or

Manual mode operation provides full control (including emission current control) from the Genius II screen. This mode of operation is generally used for predeposition evaporant conditioning. For more detailed information about Manual mode operation, see section 1.5.3.

When Modify Enable is ON, the Operations>Sweep screen appears as shown in Figure 7-6, and the user can modify the currently selected sweep pattern as described in section 5.6.2. However, the modified sweep pattern cannot be saved under a different sweep program number or associated with a pocket other than the one currently selected.

Figure 7-6 EtherCAT>Sweep Screen when Modify Enable Is ON

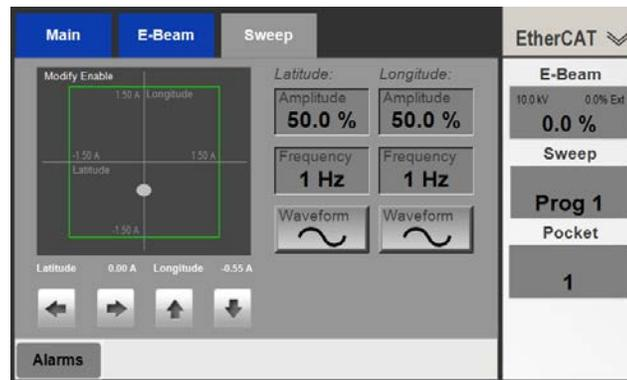

After the user presses any of the **Amplitude**, **Frequency**, or **Waveform** buttons, the screen appears as shown below.

Figure 7-7 EtherCAT>Sweep Screen, Modify Enable ON, User Modifying the Sweep Program

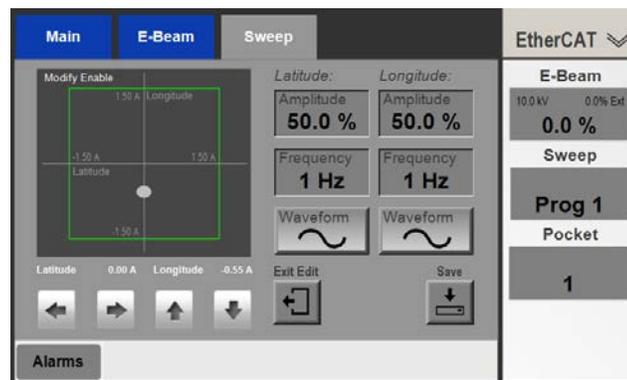

7.4 Implementing PLC Control via RS-232

This section describes how to implement PLC control via RS-232 communications and how the Genius II operates when so configured.

NOTE
For information about RS-232 protocols, see Appendix B.

7.4.1 Modifications to Hardware Cabling Procedure

| Step | Action |
|------|--|
| 1 | Perform the procedure described in section 2.3.2. |
| 2 | Using a null modem cable, connect the Genius II's rear panel Com A connector to the PC or PLC. |
| 3 | Perform Step 1 and 2 of the procedure described in section 2.4.1 to connect rear panel connector X110 to the deposition controller's emission control BNC connector. |
| 4 | Perform the procedure described in section 2.5. |

7.4.2 Modifications to Basic Configuration Procedures

To configure the Genius II to operate under the control of a PLC-based system controller, with the RS-232 option implemented, perform the modified configuration procedure described below.

| Step | Action |
|------|---|
| 1 | Perform the procedure described in sections 3.2, selecting RS-232 for External Communications . Doing this selects RS-232 for all control modules. |
| 2 | If a given control module is not implemented in your Genius II, select Offline opposite that module's name. |
| 3 | Set the system time and date by performing the procedure described in section 3.3. |
| 4 | Perform Steps 1 and 2 of the procedure described in section 3.4.1. |
| 5 | Perform Steps 4 and 5 of that procedure as written. |
| 6 | If necessary, perform the procedure described in section 3.4.2. |
| 7 | Perform the procedures described in sections 3.5 exactly as written. |
| 8 | Adjust parameters on the Config>Sweep screen as necessary (see section 3.6 for parameter definitions) |
| 9 | Perform the procedures described in sections 3.7 exactly as written. |
| 10 | Perform the procedures described in sections 3.8 and 3.9 as needed/desired. |
| 11 | Complete the configuration by performing the procedure described in section 3.10. |
| 12 | Implement the RS-232 protocols specified in Appendix B. |

7.4.3 Appearance of Operations and Manual Mode Screens when System Control via RS-232 Is Implemented

When **RS-232** is selected opposite **External Communications** on the Config>Main screen, the unit's Configuration mode screens appear as shown in Figure 1-7, its Service mode screens appear as shown in Figure 1-9, its Operations mode screens appear as shown in Figure 7-8. When the Genius II is configured this way, the Manual mode screens are identical to the Operations mode screens, except that the mode ID/menu selection button on each screen is labeled **Manual** instead of **RS-232**.

Figure 7-8 Appearance of Operations Mode Screens when RS-232 Is Selected for External Communications

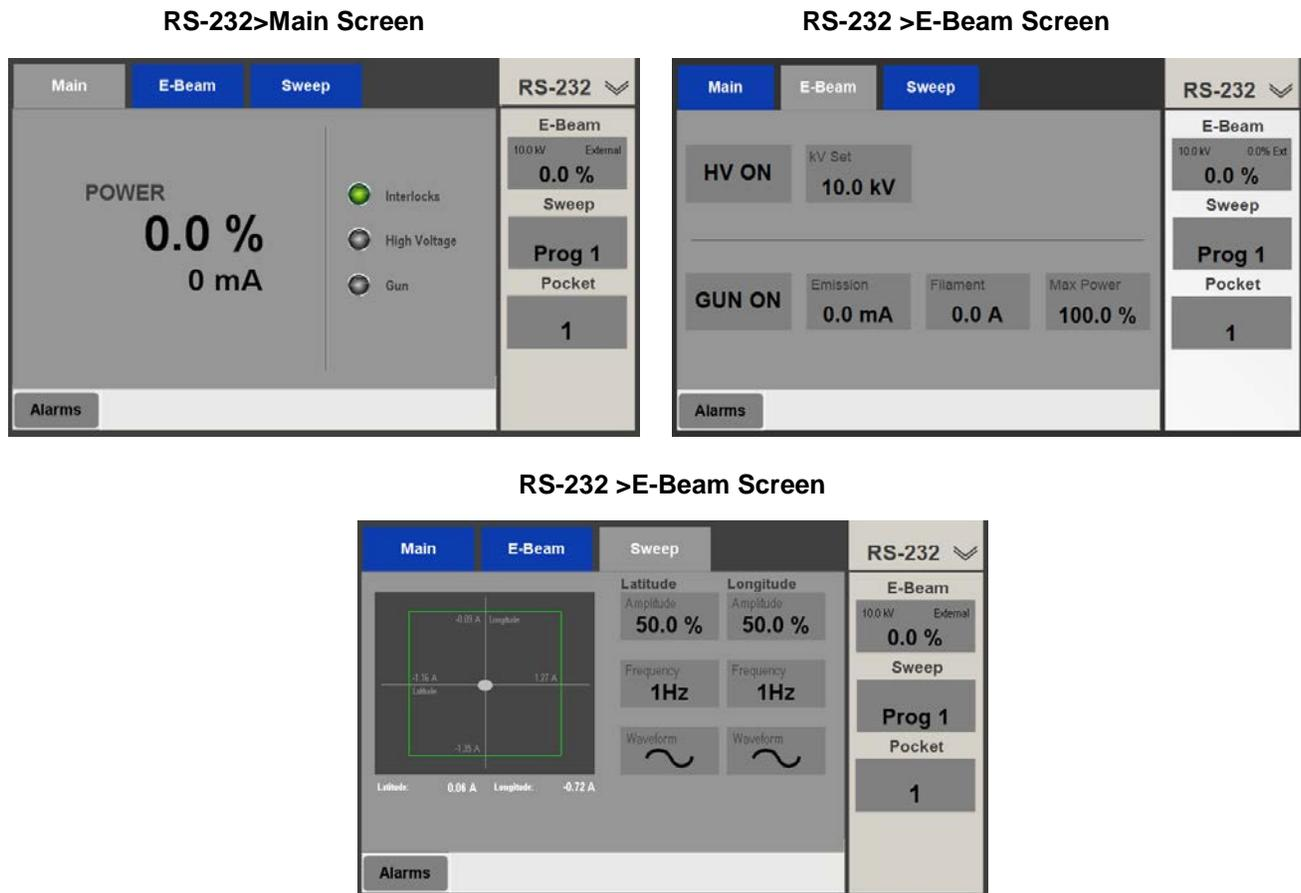

7.4.4 Operation in Operations and Manual Modes when Control Modules Are Configured as RS-232

When the Genius II's RS-232 option is implemented, the unit is completely under the control of the PLC-based system controller and the deposition controller, except when:

- the unit is in Manual mode.
- the PLC-based system controller asserts the Modify Enable signal, or

Manual mode operation provides full control (including emission current control) from the Genius II screen. This mode of operation is generally used for predeposition evaporant conditioning. Manual Mode screens (see Figure 1-10) are functionally identical to Operations Mode screens when all control modules are configured as **Local**.

When Modify Enable is ON, the Operations>Sweep screen appears as shown in Figure 7-9, and the user can modify the currently selected sweep pattern as described in section 5.6.2. However, the modified sweep pattern cannot be saved under a different sweep program number or associated with a pocket other than the one currently selected.

Figure 7-9 RS-232>Sweep Screen when Modify Enable Is ON

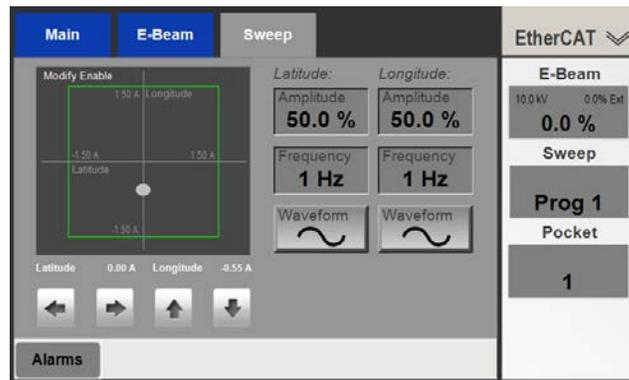

After the user presses any of the **Amplitude**, **Frequency**, or **Waveform** buttons, the screen appears as shown below.

Figure 7-10 RS-232>Sweep Screen, Modify Enable ON, User Modifying the Sweep Program

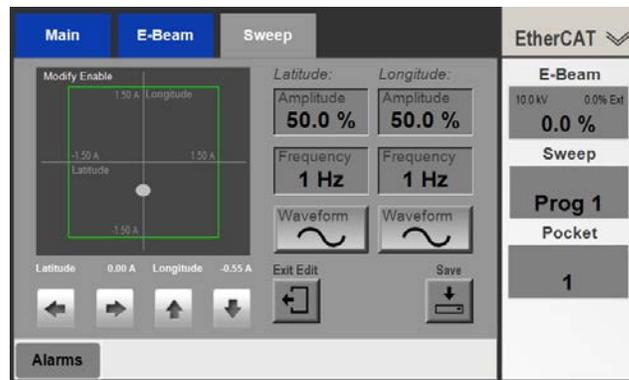

8.1 Section Overview

This section describes the main UI screens dedicated that aid in troubleshooting procedures. The subsections are:

Section 8.2 The Diagnostics Screen

Section 8.2.1 Functional Definitions of LED Indicators on the Diagnostics Screen

Section 8.3 Genius II Service Mode Screens

Section 8.3.1 The Service>E-Beam Screen

Section 8.3.2 The Service>Sweep Screen

Section 8.3.3 The Service>Turret Screen

Section 8.4 Alarm Messages

8.2 The Diagnostics Screen

Figure 8-1 shows the Config>Main screen when the auxiliary menu is displayed. To open the Diagnostics screen when this menu is displayed, touch the menu's **Diagnostics** button.

Figure 8-1 Operations>Main Screen with Auxiliary Menu Displayed

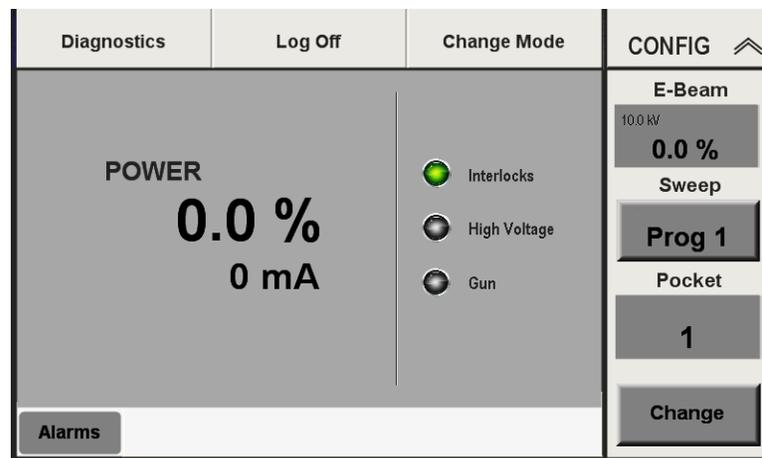
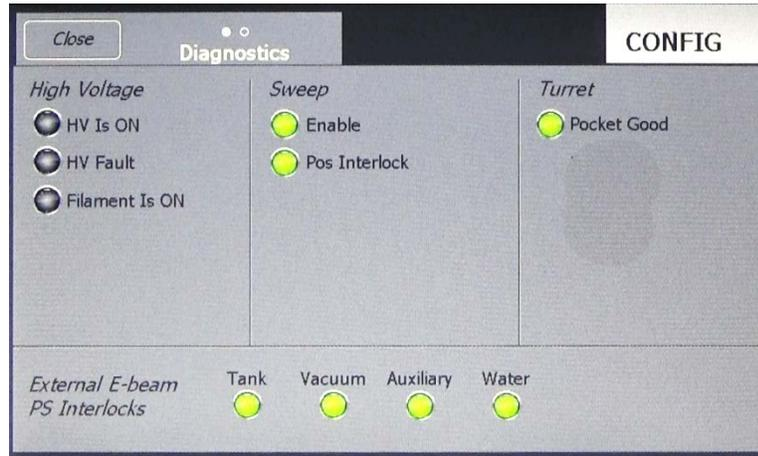
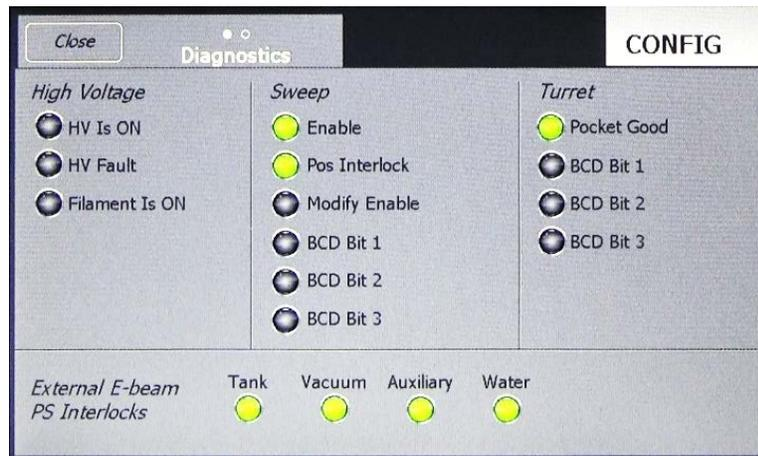

Figure 8-2 shows the Diagnostics screen as it appears in when all control modules are configured as **Local**. Figure 8-3 shows the same screen when all control modules are configured as **Remote I/O**, **EtherCAT**, or **RS232**. Section 8.2.1 provides functional definitions of the LEDs shown in Figure 8-3.

Figure 8-2 Diagnostics Screen, All Control Modules Configured as *Local*Figure 8-3 Diagnostics Screen When All Control Modules Are Configured as *Remote I/O*

8.2.1 Functional Definitions of LED Indicators on the Diagnostics Screen

Except where otherwise indicated, the LED indicators on this screen are gray (off) when the signal in question is false and green when it is true.

High Voltage Section

- **HV is ON LED:** Status of the IS ON input from the HVPS
- **HV Fault LED:** On systems with CV6-SLX and CV12-SLX HV power supplies, this LED indicates the status of the HV FAULT input from the HVPS. It is green when that input is false and red when that signal is true, indicating that a latching power supply fault has occurred. For additional information about latching HVPS faults, see section 6.2.1 of the power supply manual.
- **Filament Is ON LED:** Indicates the status of the GUN IS ON input from the filament power supply

Sweep Section

- **Enable** LED: Active only if the Genius II is connected to a PLC-based control system. This LED is off (gray) when the MODIFY ENABLE input from the higher-level controller is false. LED turns green when that input is true, indicating that sweep programs can be modified from the Operations>Sweep screen (or EtherCAT>Sweep screen or RS232>Sweep screen) of the Genius II.
- **Pos Interlock** LED: Indicates the state of the beam position interlock, as determined by the Genius II's internal sweep-control board. This LED is green when the coil-drive output is within the user-set interlock limits and red when the coil-drive output is beyond any of the four limits. If the beam and the sweep are both on, the Genius II switches off the beam as soon as it goes beyond any of the four position limits. As long as the sweep is enabled, the **Pos interlock** indicator then alternates between green and red as the beam goes from within position limits to outside limits and back again.
- **Modify Enable** LED: Active only if the Genius II is connected to a PLC-based control system. LED is off (gray) when the MODIFY input from the higher-level controller is false. It turns green when that input is true, indicating that sweep programs can be modified from the Operations>Sweep screen (or EtherCAT>Sweep screen or RS232>Sweep screen) of the Genius II.

Turret Section

- **Pocket Good** LED: Indicates the status of the POCKET GOOD input from the mechanical turret drive unit.
- **Interlock** LED: Indicates the status of the INTERLOCK input from the mechanical turret drive unit.
- LEDs for **BCD Bits 1-3**: When lit, each of these LEDs indicates that the BCD bit in question is true.

External E-Beam PS Interlocks Section

The **Tank**, **Vacuum**, **Auxiliary**, **Water**, and **Position** LEDs indicate the state of the corresponding inputs from the HVPS and the FPS, which in turn reflect that state of the external interlock switches that must be made before the gun or HV can be enabled.

8.3 Genius II Service Mode Screens

8.3.1 The Service>E-Beam Screen

Figure 8-4 shows the Service>E-Beam screen, whose control/display features are described below the illustration.

Figure 8-4 The Service>E-Beam Screen

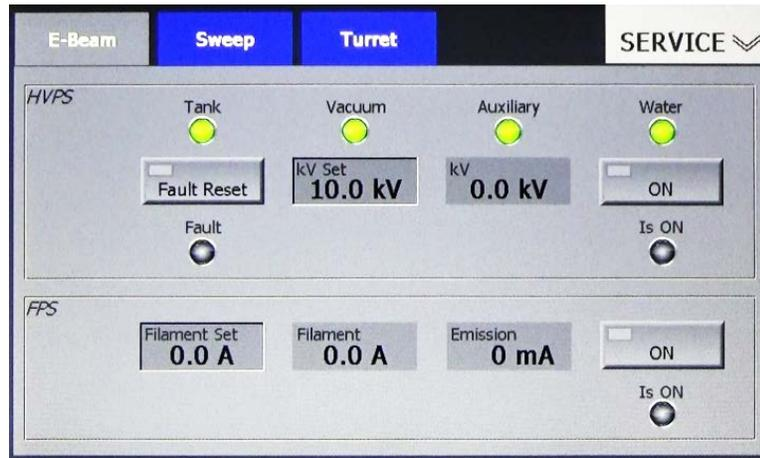

Interlocks Section

A given interlock LED is green when corresponding interlock is made and off when it is not made.

HVPS Section

The control/display features of this section are:

- **Fault Reset** button: Enables the user to assert and test the Genius II's RESET FAULT output. The rectangular indicator in the upper left-hand corner of this button turns green when that signal is asserted.
- **Fault** LED: Indicates that an HVPS fault has occurred.
- **kV Set** button: Enables user to change the kV output of the HVPS. The neighboring rectangle labeled **kV** indicates the actual HV output of the HVPS.
- **ON** button: Enables the user to assert and test the Genius II's HV ON output. The rectangular indicator in the upper left-hand corner of this button turns green when that signal is asserted.
- **Is ON** LED: Lights to indicate that the HV is switched on.

FPS Section

The control/display features of this section are:

- **Filament Set** button: Enables the user to change the filament current setpoint. The neighboring rectangle labeled **Filament** indicates the actual filament current, while the **Emission** rectangle indicates the actual emission current.
- **ON** button: Enables the user to assert and test the GUN ON output. The rectangular indicator in the upper left-hand corner of this button turns green when that signal is asserted.
- **Is ON** LED: Lights to indicate that the filament current is on.

8.3.2 The Service>Sweep Screen

Figure 8-5 shows the Service>Sweep screen.

Figure 8-5 The Service>Sweep Screen

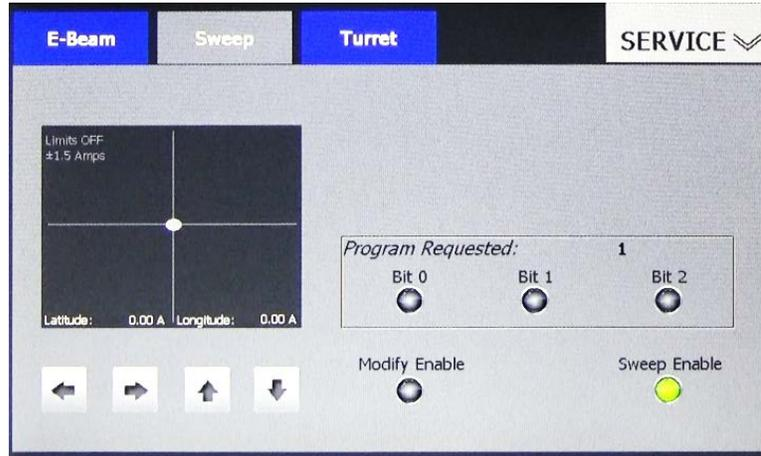

The **Bit 1**, **Bit 2**, and **Bit 3** LEDs in the **PROGRAM REQUESTED** section of this screen are operational only if the Genius II is connected to a PLC-based system controller, in which case these LEDs turn green when the corresponding BCD-coded inputs are true. Likewise, the **Sweep Enable** and **Modify Enable** LEDs functions only if the Genius II is connected to a PLC-based system controller.

8.3.3 The Service>Turret Screen

Figure 8-6 shows the Service>Turret screen.

Figure 8-6 The Service>Turret Screen

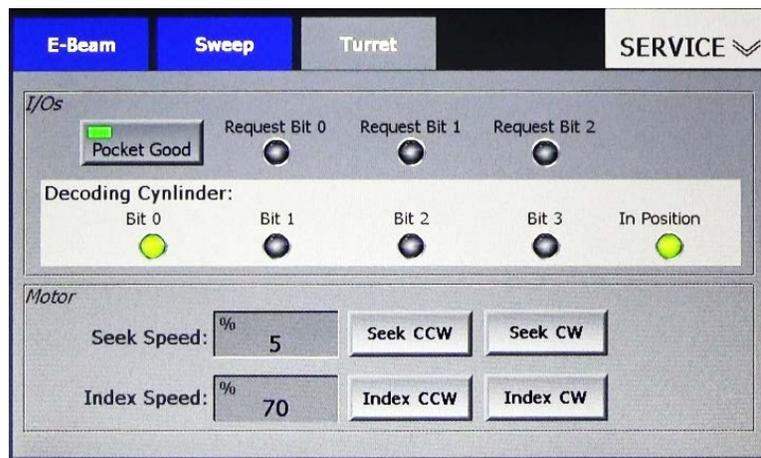

The buttons on this screen provide the following command functions.

- The **Seek CCW** button enables user to jog turret counterclockwise at seek speed
- The **Seek CW** button enables user to jog the turret clockwise at seek speed
- The **Index CCW** button enables user to jog turret counterclockwise at index speed
- The **Index CW** button enables user to jog the turret clockwise at index speed
- The **Pocket Good** button enables the user to assert and test the POCKET GOOD input

The LED indicators on this screen light to indicate that the corresponding I/Os are true, but they function only if the Genius II is connected to a PLC-based system controller.

8.4 Alarm Messages

The Genius II displays the alarm messages listed below, most of which should be self-explanatory. Explanations for those that are not self-explanatory are provided below the list.

AnyBus Gateway Lost Communication*

Aux Interlock Alarm

FPS Fail to Detect Emission

FPS Gun Ctlr Go On Timeout

FPS Module Lost Communication

HVPS Faulted Alarm

HVPS Go On Timeout

HVPS Is On Failure

Loopback Alarm*

Loopback Interlock Alarm*

Sweep Communication Interlock Alarm

Sweep Module Lost Communication

Tank Interlock Alarm

Turret Failed To Find Position

Turret Module Lost Communication

Vacuum Interlock Alarm

Water Supply Interlock Alarm

*Displayed only when the Genius II is under the control of a PLC-based system controller using EtherCAT communications.

- **AnyBus Gateway Lost:** This message is displayed when communication is lost between the **EtherCAT** connector on the Genius II rear panel and the EtherCAT gateway, which generally indicates that the cable connecting them is either defective or not making good contact at one end or the other.
- A **Loopback Alarm** occurs if the Genius II fails to detect the loopback from the PLC side of the EtherCAT gateway.
- A **Loopback Interlock Alarm** occurs if the user attempts to switch on the e-beam when a **Loopback Alarm** is in force.

9 Maintenance Procedures

9.1 Section Overview

This section describes the main UI screens dedicated that aid in troubleshooting procedures. The subsections are:

Section 9.2 Replacing a Control Module

Section 9.3 Replacing the Hard Drive

9.2 Replacing a Control Module

This section describes how to replace one of the Genius II's four control modules, taking the Indexer Control module as an example.

| <u>Step</u> | <u>Action</u> |
|-------------|---|
| 1 | Use the Genius II's rear-panel On/Off switch (see Figure 2-9) to power down the unit |
| 2 | Unplug the power cable from its rear panel receptacle. |
| 3 | Detach all cables and the ground wire from the Genius II rear panel. |
| 4 | Remove the 10 screws securing the unit's top cover to its chassis and remove the top cover. |
| 5 | Find the Control module that you wish to remove (see Figure 9-1). |

Figure 9-1 Genius II Control PCBs Identified

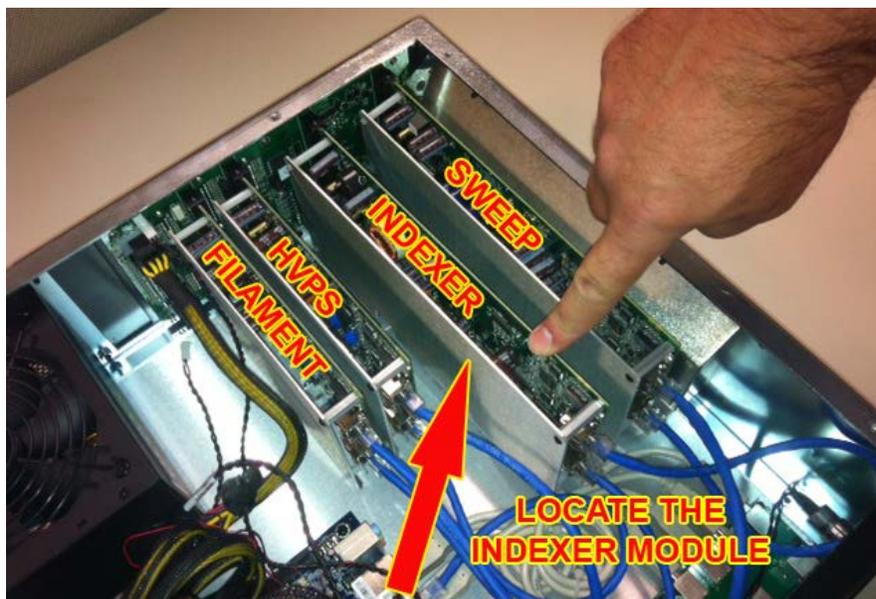

- 6 Unplug the top and bottom cables that are connected to the target module (see Figures 9-2 and 9-3). Label these as Top and Bottom.

Figure 9-2 Unplugging the Upper Cable from the Indexer Control Module

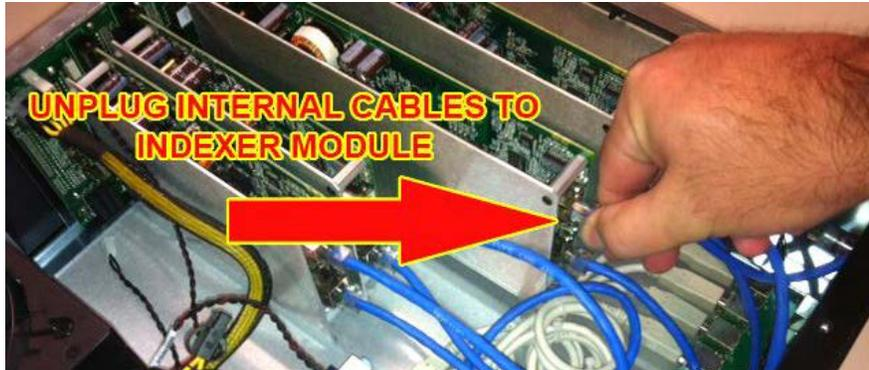
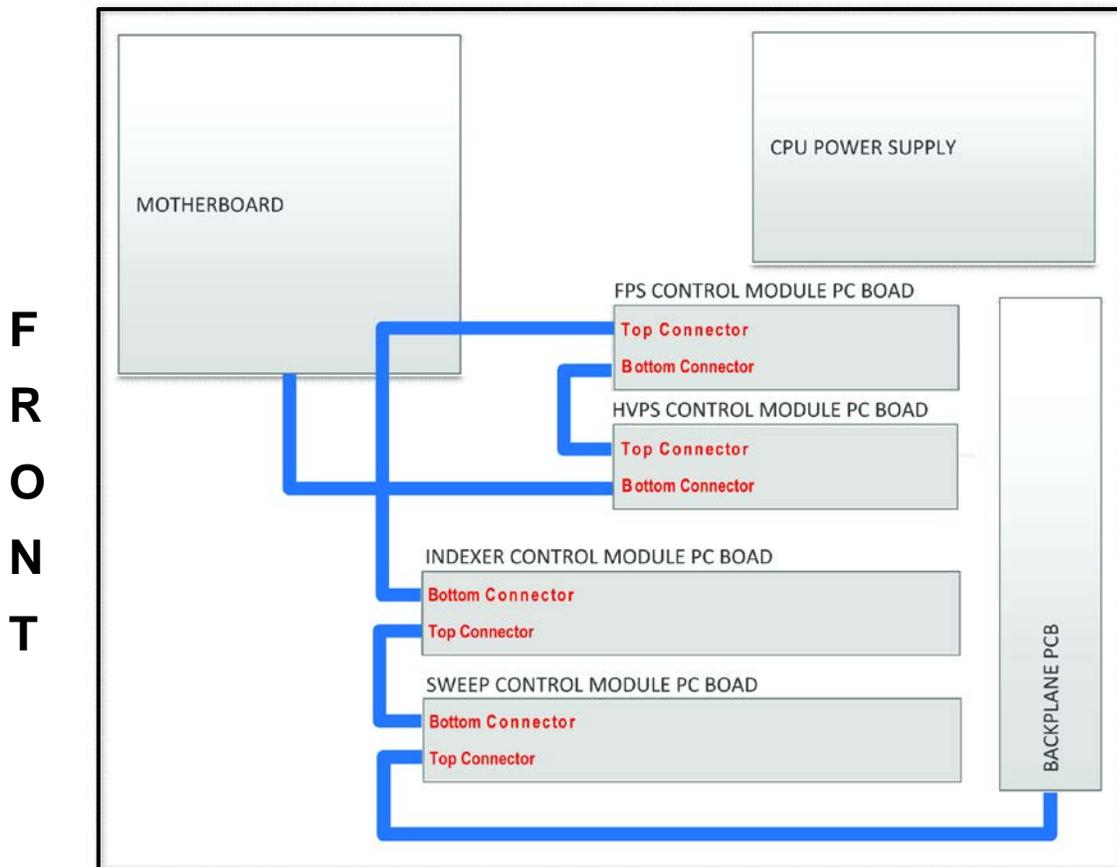
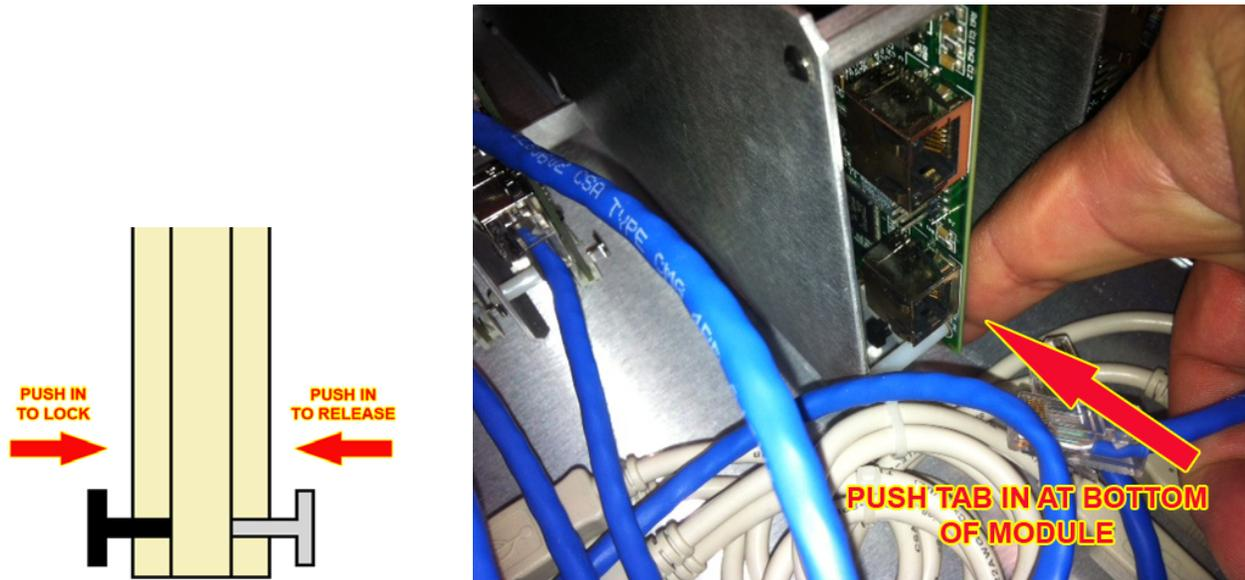

Figure 9-3 EtherCat Connections Between Internal Genius II Components



- 7 Release the control module by pushing in the silver tab on the PCB guide rail near the bottom of the right side of the control module (see Figure 9-4).

Figure 9-4 Unplugging the Upper Cable from the Indexer Control Module



- 8 Grasp the control module by its upper front standoff and carefully lift the module out of the chassis, as shown in Figure 9-5.

Figure 9-5 Removing the Control Module from the Genius II Chassis



- 9 Carefully install the new control module (see Figure 9-6), ensuring that the bottom of the PCB is properly seated in the guide rail.

NOTE

Make sure that the PCB is fully seated in its socket in the back plane.

Figure 9-6 Installing the New Control Module

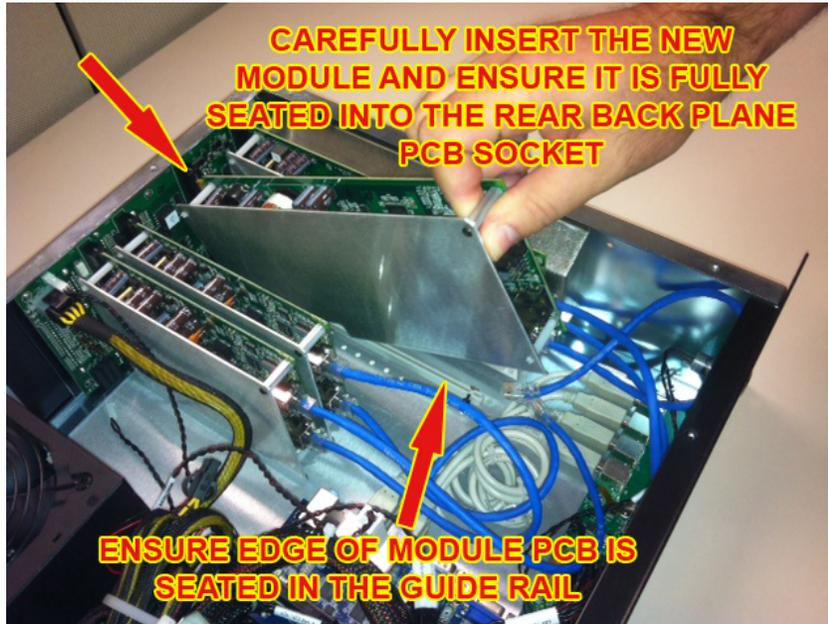

NOTE
Figure 9-7 shows the cutout in the bottom of the module's metal case. This cutout fits over the support rail in the bottom of the Genius II chassis.

Figure 9-7 Cutout in Bottom of Control Module

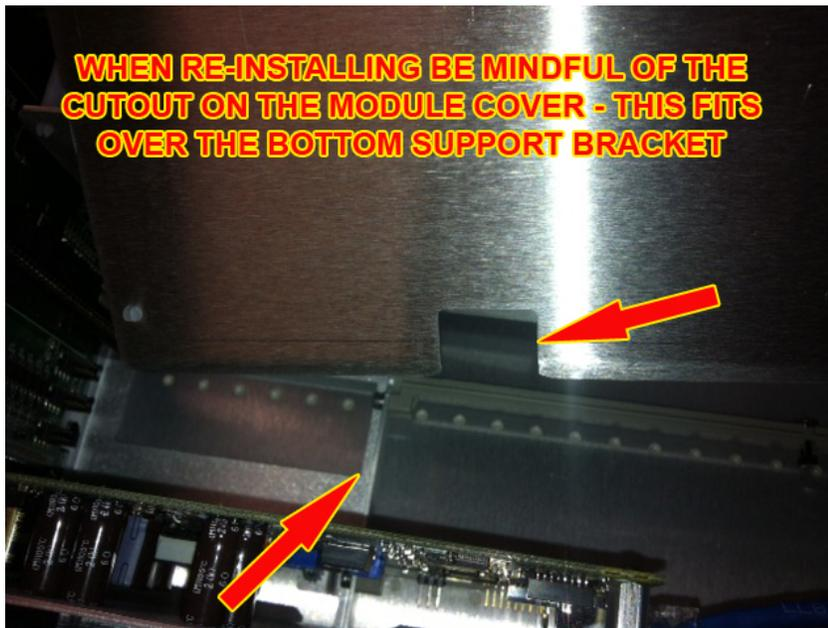

- 10 Plug the cable into the connectors near the top and bottom of the control module (see Figure 9-8).

NOTE

Make sure each cable is plugged into the correct connector.

Figure 9-8 Plugging Cables into the New Control Module



- 11 If the maintenance procedure is completed, perform Steps 1-4 of this procedure in reverse order and resume operation of the Genius II.

9.3 Replacing the Hard Drive

Follow the steps described below when replacing the unit's hard drive.

| <u>Step</u> | <u>Action</u> |
|-------------|---|
| 1 | Use the Genius II's rear-panel On/Off switch (see Figure 2-9) to power down the unit |
| 2 | Unplug the power cable from its rear panel receptacle. |
| 3 | Detach all cables and the ground wire from the Genius II rear panel. |
| 4 | Remove the 10 screws securing the unit's top cover to its chassis and remove the top cover. |
| 5 | Locate the hard drive, which is plugged into the mother board (see Figure 9-9). |

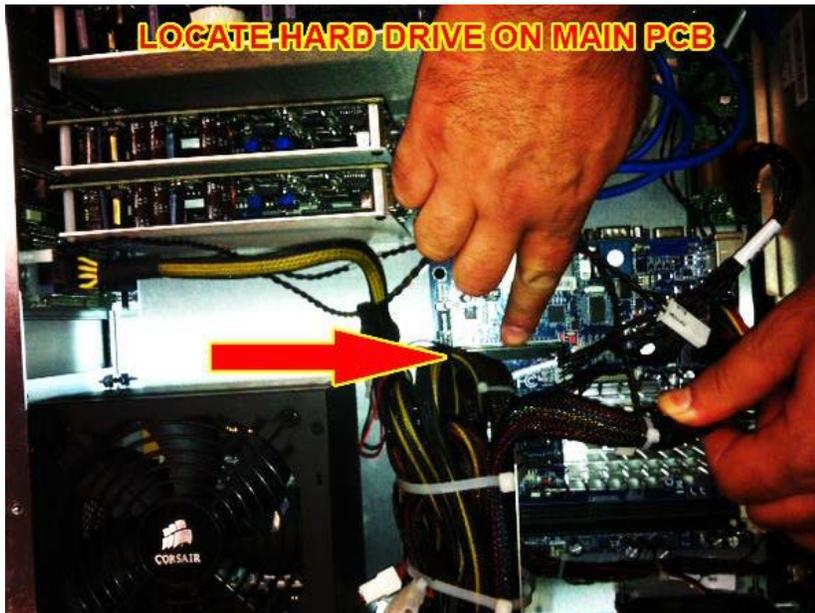
Figure 9-9 Location of Hard Drive on Mother Board

- 6 Remove the hard drive from the mother board. To do so, grasp both sides of the hard drive and pull it straight up and out of its socket (see Figure 9-10).

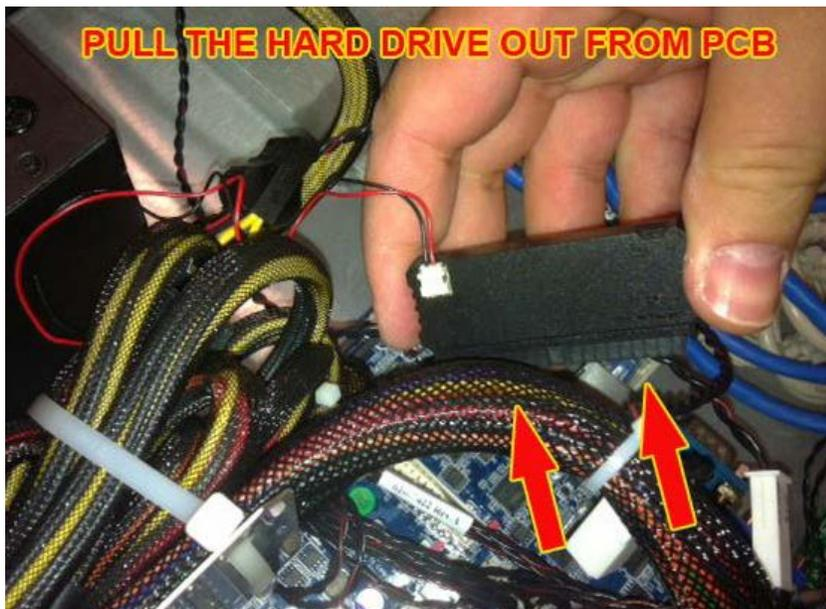
Figure 9-10 Removing the Hard Drive from the Mother Board

- 7 Unplug the cable that is plugged into the top of the hard drive (see Figure 9-11).

Figure 9-11 Unplugging the Hard Drive Cable

- 8 Plug the hard drive cable into the cable on the new hard drive (see Figure 9-12).

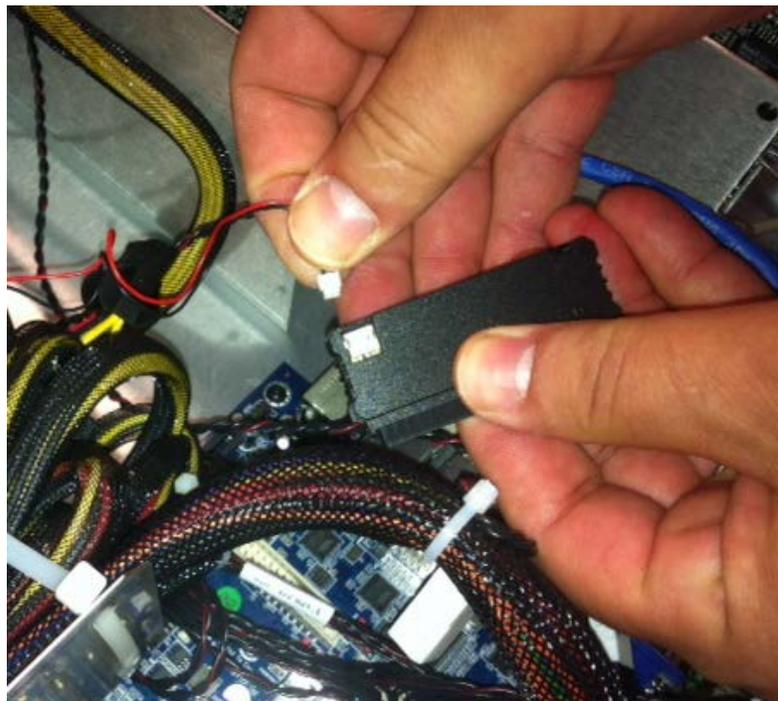
Figure 9-12 Plugging the Hard Drive Cable into the New Hard Drive

- 9 Plug the new hard drive into its socket in the motherboard, as shown in Figure 9-13.

NOTE

Be aware that the hard drive and the socket are both keyed, and make sure that these keyed are properly lined up, as it is possible to misalign the pins.

Figure 9-13 Plugging the New Hard Drive into its Socket in the Mother Board



- 10 Double-check to verify that the hard drive is properly seated in its socket.
- 11 If the maintenance procedure is completed, perform Steps 1-4 of this procedure in reverse order and resume operation of the Genius II.

Appendix A: Gateway Selection and Memory Map for PLC Control Network Implementation

Table A-1 Anybus Gateway Selection

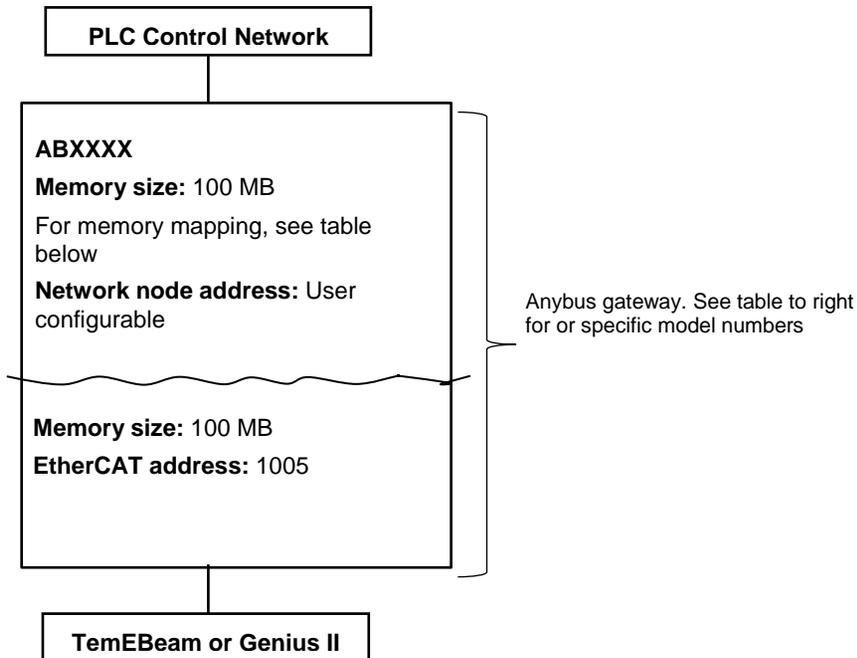

| AnyBus Model Number | PLC Network Type |
|---------------------|------------------------|
| AB7682 | Ethernet /IP slave |
| AB7684 | PROFINET I/O slave |
| AB7685 | PROFIBUS slave |
| AB7686 | DeviceNet slave |
| AB7687 | ControlNet slave |
| AB7688 | FIP slave |
| AB7689 | Interbus slave Cu |
| AB7690 | Interbus slave Fo |
| AB7691 | CANopen slave |
| AB7692 | Modbus RTU slave |
| AB7693 | Modbus Plus slave |
| AB7694 | CC Link |
| AB7695 | LONWorks |
| AB7900 | EtherCAT slave |
| AB7901 | Ethernet MBTCP slave |
| AB7961 | CC-Link IE Field Slave |

Table A-2 Memory Map: EtherCAT Interface For Genius II & TemEbeam

Supportive Genius II Software Version: TemEbeam-Genius2 (AnyBus) v1.6.1 or higher
Supportive TemEbeam Software Version: EBC 1.6.x or higher

General (Set parameters)

| Function | Word | Byte | Bit | Data Type | Range | Comment |
|-------------------|------|------|-----|-----------|----------|---|
| Alarm Acknowledge | 0 | 0 | 0 | Bool | 0,1 | Positive Edge Trigger (Minimum 50 milliseconds pulse) |
| Comm Loopback Tx | 0 | 0 | 7 | Bool | 0,1 | Need to set "Loopback Return = Loopback Receive" |
| | 0 | 1 | N/A | USINT | Not Used | |
| | 1 | 2,3 | N/A | UINT | Not Used | |
| | 2 | 4,5 | N/A | UINT | Not Used | |

(Works only works when Ebeam control module is in "EtherCAT" Operations mode.)

Ebeam (Set parameters)

| Function | Word | Byte | Bit | Data Type | Range | Comment |
|------------------|------|-------|-----|-----------|--------------|-------------------------------------|
| HVPS Go On | 3 | 6 | 0 | Bool | 0,1 | 0=OFF, 1=ON |
| FPS Go On | 3 | 6 | 1 | Bool | 0,1 | 0=OFF, 1=ON |
| | 3 | 7 | N/A | USINT | Reserved | |
| HVPS Voltage Set | 4 | 8,9 | N/A | UINT | 0 ... 10,000 | 0 ... 10 kV (resolution = 0.001 kV) |
| FPS Emission Set | 5 | 10,11 | N/A | UINT | 0 ... 10,000 | 0 ... 100% (resolution = 0.01%) |
| | 6 | 12,13 | N/A | UINT | Not Used | |

(Works only when Turret control module is in "EtherCAT" operations mode.)

Turret (Set parameters)

| Function | Word | Byte | Bit | Data Type | Range | Comment |
|--------------------------------|------|------|-----|-----------|-----------|-------------------------------|
| Turret In-Pocket Jog Go On | 7 | 14 | 0 | BOOL | 0,1 | |
| Turret Pocket Select | 7 | 15 | N/A | USINT | 1 ... 8 | |
| Turret In-Pocket Jog Speed Set | 8 | 16 | N/A | USINT | 0 ... 100 | 0 ... 100 % (resolution = 1%) |
| | 8 | 17 | N/A | USINT | Not Used | |

(Works only when Sweep control module is in "EtherCAT" Operations mode.)

Sweep
(Set parameters)

| Function | Word | Byte | Bit | Data Type | Range | Comment |
|----------------------|------|-------|-----|-----------|----------|---------------|
| Sweep Enable | 9 | 18 | 0 | Bool | 0,1 | |
| Sweep Modify Enable | 9 | 18 | 1 | Bool | 0,1 | |
| Sweep Go On | 9 | 18 | 2 | Bool | 0,1 | Not Available |
| Sweep Program Select | 9 | 19 | N/A | USINT | 1 ... 10 | |
| | 10 | 20,21 | N/A | UINT | Not Used | |

General
(query parameters)

| Function | Word | Byte | Bit | Data Type | Range | Comment |
|---------------------------|------|-------------|-----|-----------|-------------------|---|
| Login Is Enabled | 0 | 0 | 0 | Bool | 0,1 | 0=disabled, 1=enabled |
| Alarm Status | 0 | 0 | 2 | Bool | 0,1 | 0= no alarm, 1= in alarm(s) |
| Parameter(s) Out of Range | 0 | 0 | 3 | Bool | 0,1 | 0= No error, 1= Out of range |
| Comm Loopback Rx | 0 | 0 | 7 | Bool | 0,1 | Loopback receive |
| Current MODE | 0 | 1 | N/A | USINT | 0 ... 3 | 0-6 = Null, Standby, MasterSlave, Operate, Manual , Config, Service |
| Administrator Password | 1 | 2,3 | N/A | UINT | 0 ... 65535 | |
| | 2 | 4,5 | N/A | UINT | Reserved | |
| Alarm Block 1 | 3,4 | 6,7,8,9 | N/A | DWORD | 0,1,2 ... 32 bits | See Alarm Block 1 table below |
| Alarm Block 2 | 5,6 | 10,11,12,13 | N/A | DWORD | Not Used | |
| | 7,8 | 14,15,16,17 | N/A | DWORD | Not Used | |
| | 9,10 | 18,19,20,21 | N/A | DWORD | Not Used | |

Ebeam
(query parameters)

| Function | Word | Byte | Bit | Data Type | Range | Comment |
|-----------------------------|------|-------|-----|-----------|--------------|--------------------------------------|
| HVPS Is Faulted | 11 | 22 | 0 | Bool | 0,1 | |
| HVPS Is On | 11 | 22 | 1 | Bool | 0,1 | |
| FPS Is On | 11 | 22 | 2 | Bool | 0,1 | |
| | 11 | 23 | N/A | USINT | Not Used | |
| | 12 | 24,25 | N/A | UINT | Not Used | - |
| HVPS Actual Voltage | 13 | 26,27 | N/A | UINT | 0 ... 10,000 | 0 ... 10 kV (resolution =1 V) |
| FPS Actual Filament Current | 14 | 28,29 | N/A | UINT | 0 ... 5,000 | 0 ... 50 A (resolution = 0.01 A) |
| FPS Actual Emission (in mA) | 15 | 30,31 | N/A | UINT | 0 ... 10,000 | 0 ... 1,000 mA (resolution = 0.1 mA) |
| | 16 | 32,33 | N/A | UINT | Not Used | |

Interlocks
(query parameters)

| Function | Word | Byte | Bit | Data Type | Range | Comment |
|-------------------------------|------|------|-----|-----------|----------|-----------------|
| H ₂ O Interlock Ok | 17 | 34 | 0 | Bool | 0,1 | |
| Aux Interlock Ok | 17 | 34 | 1 | Bool | 0,1 | |
| Vacuum Interlock Ok | 17 | 34 | 2 | Bool | 0,1 | |
| Tank Interlock Ok | 17 | 34 | 3 | Bool | 0,1 | |
| Poptop Is Down | 17 | 34 | 4 | Bool | 0,1 | (TemEbeam Only) |
| | 17 | 35 | N/A | USINT | Not Used | |

Turret
(query parameters)

| Function | Word | Byte | Bit | Data Type | Range | Comment |
|-------------------------------|------|-------|-----|-----------|----------|--|
| Turret Pocket Is Valid | 18 | 36 | 0 | Bool | 0,1 | |
| Turret Motor Is ON | 18 | 36 | 1 | Bool | 0,1 | |
| Turret Motor Is Activated | 18 | 36 | 2 | Bool | 0,1 | |
| Turret Actual Pocket Position | 18 | 37 | N/A | USINT | 0 ... 50 | 0=unknown position, 1 ... 50 = Actual Pocket |
| | 19 | 38,39 | N/A | UINT | Reserved | |
| | 20 | 40,41 | N/A | UINT | Not Used | |

Sweep
(query
parameters)

| Function | Word | Byte | Bit | Data Type | Range | Comment |
|--------------------------|------|-------|-----|-----------|-------------|--------------------------------------|
| Sweep Position Interlock | 21 | 42 | 0 | Bool | 0,1 | 0= Interlock Not OK, 1= Interlock OK |
| Sweep Program Is In Edit | 21 | 42 | 1 | Bool | 0,1 | |
| Sweep Program Actual | 21 | 43 | N/A | USINT | 1 ... 10 | |
| Sweep Latitude Current | 22 | 44,45 | N/A | UINT | 0 ... 2,000 | -5 ... 5 A (resolution = 0.005 A) |
| Sweep Longitude Current | 23 | 46,47 | N/A | UINT | 0 ... 2,000 | -5 ... 5 A (resolution = 0.005 A) |
| | 24 | 48,49 | N/A | UINT | Not Used | |

Alarms Block 1

| Bit | Alarm Description |
|-----|-------------------------------------|
| 0 | HVPS Go On Timeout |
| 1 | HVPS Is On Failure |
| 2 | HVPS Faulted Alarm |
| 3 | FPS Gun Ctrl Go On Timeout |
| 4 | FPS Fail To Detect Emission |
| 5 | Turret Failed To Find Position |
| 6 | Turret Missing Interlock Wire |
| 7 | Water Supply Interlock Alarm |
| 8 | Aux Interlock Alarm |
| 9 | Vacuum Interlock Alarm |
| 10 | Tank Interlock Alarm |
| 11 | Sweep Communication Interlock Alarm |
| 12 | FPS Module Lost Communication |
| 13 | HVPS Module Lost Communication |
| 14 | Turret Module Lost Communication |
| 15 | Sweep Module Lost Communication |
| 16 | AnyBus Gateway Lost Communication |
| 17 | Comm Loop Back Not Detected |
| 18 | Comm Loop Back Interlock Alarm |
| 19 | Null |
| 20 | Null |
| 21 | Null |
| 22 | Null |
| 23 | Null |
| 24 | Null |
| 25 | Null |
| 26 | Null |
| 27 | Null |
| 28 | Null |
| 29 | Null |
| 30 | Null |
| 31 | Null |

Appendix B: Host Computer–Genius II RS-232 Communications Protocol

Port Configuration

Connect a standard null modem (crossover) cable to the host computer and to the rear panel **COM B** port on the Genius II. The diagram below shows the pinout.

Figure B-1 Connections: Genius II COM B Port to RS-232 Connector on Host Computer

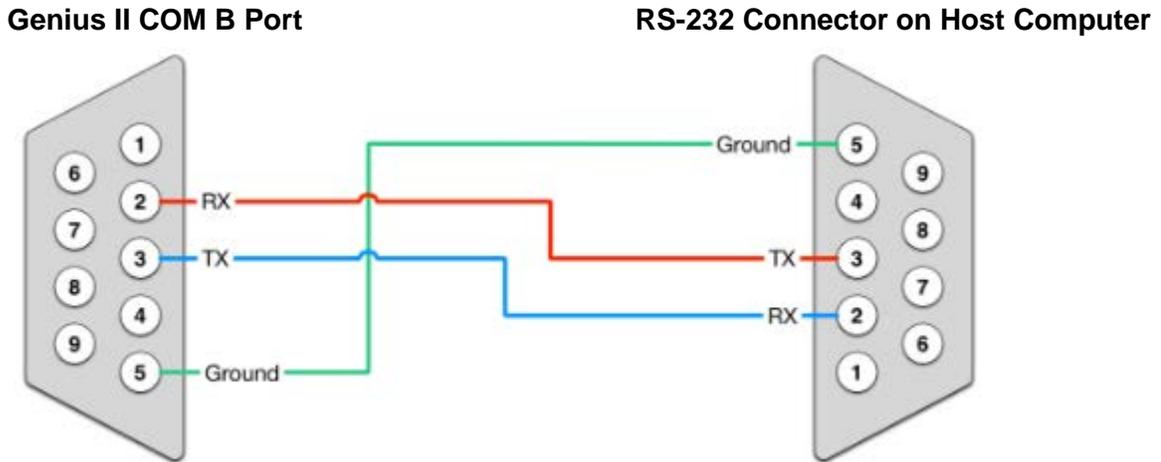

Set your computer to a baud rate of **38400, no parity, 8 data bits and 1 stop bit.**

General Message Format

General message format, whether message sent to CONTROLLER or received from CONTROLLER:

<ESC>XX P₀ P_n<CR>

Detail:

<ESC> = Escape character, ASCII 27₁₀ = 1B₁₆. This character is not expected by the receiver, but it should cause the receiver to clear its receive buffer.

<CR> = Carriage Return character, ASCII 13₁₀ = 0D₁₆

<LF> = Line Feed character, ASCII 10₁₀ = 0A₁₆. Line Feed characters are not required but may appear anywhere in a message and are ignored by the receiver.

XX = two letter command code, see below "Command Codes".

P₀ = First parameter, typically 1 to 5 decimal digits.

P_n = Subsequent parameter(s), if any, typically 1 to 5 decimal digits.

Space character, ASCII 32₁₀ = 20₁₆. A single space character must appear between the command code and first parameter (if any), as well as between all parameters.

Command Codes

GV = Get Value. Host requests the current value of a particular variable in the CONTROLLER.

SV = Set Value. Hosts requests that a particular variable in the CONTROLLER be set to the specified value.

Command GV Detail

Host to CONTROLLER:

<ESC>GV P_{id}<CR>

P_{id} = Parameter ID (from table). P_{id} = 0 means "report all CONTROLLER variables".

CONTROLLER to host:

<ESC>gv P_{id} V<CR>

V = Value (unsigned decimal number, 1 to 5 digits).

Note: if P_{id} is unrecognized, then V is omitted in the response.

Command SV Detail

Host to CONTROLLER:

<ESC>SV P_{id} V<CR>

P_{id} = Parameter ID (from table).

V = Value (unsigned decimal number, 1 to 5 digits).

CONTROLLER to host:

<ESC>sv P_{id} V<CR>

V = Value (unsigned decimal number, 1 to 5 digits).

Note: if P_{id} is unrecognized, then V is omitted in the response. If the value V is out of range or otherwise invalid, the CONTROLLER shall set the value of P_{ID} to the nearest acceptable value and return that value as V.

| P _{id} | GV | SV | Tem-Ebeam | Genius2 | Function | Range | Units/Count | Comment |
|-----------------|----|----|-----------|---------|-----------------------------|-----------------|-------------|--|
| 0 | ✓ | | ✓ | ✓ | Get All Parameters | 0 .. 1 | | |
| | | | | | SYSTEMS PARAMETERS | | | |
| 1 | ✓ | | ✓ | ✓ | Comm Watchdog Rx | 0 .. 1 | | Comm Bit Receive |
| 2 | ✓ | ✓ | ✓ | ✓ | Comm Watchdog Tx | 0 .. 1 | | Comm Bit Transmit, echo response of Tx with the Rx value (Tx = Rx) |
| 3 | ✓ | | ✓ | ✓ | Get Login Enable | 0 .. 1 | | 0=disabled, 1=enabled |
| 4 | ✓ | | ✓ | ✓ | Get User 1 Priviledges | 0 .. 7 | | 0000001b=operate, 0000010b=manual, 00000100b=cfg/service |
| 5 | ✓ | | ✓ | ✓ | Get User 2 Priviledges | 0 .. 7 | | 0000001b=operate, 0000010b=manual, 00000100b=cfg/service |
| 6 | ✓ | | ✓ | ✓ | Get User 3 Priviledges | 0 .. 7 | | 0000001b=operate, 0000010b=manual, 00000100b=cfg/service |
| 7 | ✓ | | ✓ | ✓ | Get User Admin Priviledges | 0 .. 7 | | 0000001b=operate, 0000010b=manual, 00000100b=cfg/service |
| 8 | ✓ | ✓ | ✓ | ✓ | Reset Alarms | 0 .. 1 | | Rising Edge Trigger |
| 9 | ✓ | | ✓ | ✓ | Alarms | 0 .. 1 | | 0= no alarm, 1= one or more alarms present |
| 10 | ✓ | | ✓ | ✓ | Get Mode | 0 .. 6 | | 0=Null, 1=Reserved, 2=Reserved, 3=Operation (RS232), 4=Manual, 5=Configuration, 6=Service |
| ... | | | | | | | | |
| 19 | ✓ | | ✓ | ✓ | System Alarms | 0,1,2...15 bits | | See Alarm Table below |
| | | | | | HVPS/FPS INTERLOCKS | | | |
| 20 | ✓ | | ✓ | ✓ | HVPS/FPS Interlock Alarms | 0,1,2...15 bits | | See Alarm Table below |
| 21 | ✓ | | ✓ | ✓ | H2O Interlock Ok | 0 .. 1 | | 0 = false, 1 = true |
| 22 | ✓ | | ✓ | ✓ | External Interlock Ok | 0 .. 1 | | 0 = false, 1 = true |
| 23 | ✓ | | ✓ | ✓ | Vacuum Interlock Ok | 0 .. 1 | | 0 = false, 1 = true |
| 24 | ✓ | | ✓ | ✓ | Tank Interlock Ok | 0 .. 1 | | 0 = false, 1 = true |
| 25 | ✓ | | ✓ | ✓ | Poptop Is Down | 0 .. 1 | | 0 = false, 1 = true |
| | | | | | HVPS/FPS PARAMETERS | | | The Ebeam option must be configured for RS232 and the controller is set to "operate" mode. |
| 30 | ✓ | | ✓ | ✓ | HVPS/FPS Alarms | 0,1,2...31 bits | | See Alarm Table below |
| 31 | ✓ | ✓ | ✓ | ✓ | HVPS Go On | 0 .. 1 | | 0 = off, 1 = on |
| 32 | ✓ | | ✓ | ✓ | HVPS Is On | 0 .. 1 | | 0 = off, 1 = on |
| 33 | ✓ | | ✓ | ✓ | HVPS Is Faulted | 0 .. 1 | | 0 = false, 1 = true |
| 34 | ✓ | ✓ | ✓ | ✓ | HVPS Voltage Setpoint | 0 .. 1000 | 10V | |
| 35 | ✓ | | ✓ | ✓ | HVPS Voltage Actual | 0 .. 1000 | 10V | |
| 36 | ✓ | ✓ | N/A | ✓ | Filament Select | 1 .. 3 | | |
| 37 | ✓ | ✓ | ✓ | ✓ | FPS Go On | 0 .. 1 | | 0 = off, 1 = on |
| 38 | ✓ | | ✓ | ✓ | FPS Is On | 0 .. 1 | | 0 = off, 1 = on |
| 39 | ✓ | ✓ | ✓ | ✓ | FPS Emission Setpoint | 0 .. 10000 | 0.01% | |
| 40 | ✓ | | ✓ | ✓ | FPS Emission Actual | 0 .. 10000 | 0.01% | |
| 41 | ✓ | | ✓ | ✓ | FPS Emission Actual | 0 .. 10000 | 0.1 mA | |
| 42 | ✓ | | ✓ | ✓ | FPS Actual Filament Current | 0 .. 5000 | 0.01 A | |

| P _{id} | GV | SV | Tem-Ebeam | Genius2 | Function | Range | Units/Count | Comment |
|-----------------|----|----|-----------|---------|--------------------------|-----------------|-------------|---|
| | | | | | TURRET PARAMETERS | | | The Turret option must be configured for RS232 and the controller is set to Operate mode. |
| 50 | ✓ | | ✓ | ✓ | TRC Alarms | 0,1,2...15 bits | | See Alarm Table below |
| 51 | ✓ | ✓ | ✓ | ✓ | TRC Pocket Select | 1 .. 8 | | 1 .. 8 = Pocket Request (Actuates if sweep program is NOT in edit) |
| 52 | ✓ | | ✓ | ✓ | TRC Pocket Actual | 0 .. 8 | | 0 = Unknown Position, 1 .. 8 = Actual Pocket |
| 53 | ✓ | | ✓ | ✓ | TRC Pocket Is Good | 0 .. 1 | | 0 = false, 1 = true |
| 54 | ✓ | | ✓ | ✓ | TRC Motor Is ON | 0 .. 1 | | 0 = false, 1 = true |
| 55 | ✓ | ✓ | ✓ | N/A | TRC Activate Motor | 0 .. 1 | | 0 = false, 1 = true |
| 56 | ✓ | | ✓ | N/A | TRC Motor Is Activated | 0 .. 1 | | 0 = false, 1 = true |
| 57 | ✓ | ✓ | ✓ | ✓ | TRC In-Pocket Jog Go ON | 0 .. 1 | | 0 = off, 1 = on |
| 58 | ✓ | ✓ | ✓ | ✓ | TRC In-Pocket Jog Speed | 0 .. 100 | .1RPM 1% | Controller (0-100 = 0-10.0 RPM). Genius2 (0-100 = 0-100 %) |
| | | | | | SWEEP PARAMETERS | | | The Sweep option must be configured for RS232 and the controller is set to Operate mode. |
| 60 | ✓ | | ✓ | ✓ | Sweep Alarms | 0,1,2...15 bits | | See Alarm Table below |
| 61 | ✓ | ✓ | N/A | ✓ | Sweep Source Select | 1 .. 3 | | |
| 62 | ✓ | ✓ | ✓ | ✓ | Sweep Enable | 0 .. 1 | | 0 = disabled, 1 = enabled |
| 63 | ✓ | ✓ | ✓ | ✓ | Sweep Modify Enable | 0 .. 1 | | 0 = disabled, 1 = enabled |
| 64 | ✓ | ✓ | ✓ | ✓ | Sweep Program Select | 1 .. 10 | | |
| 65 | ✓ | | ✓ | ✓ | Sweep Program Actual | 1 .. 10 | | |
| 66 | ✓ | | ✓ | ✓ | Sweep Latitude Current | 0 .. 2000 | 0.01A | 0 = -10.00A, 2000 = +10.00A |
| 67 | ✓ | | ✓ | ✓ | Sweep Longitude Current | 0 .. 2000 | 0.01A | 0 = -10.00A, 2000 = +10.00A |
| 68 | ✓ | | ✓ | ✓ | Sweep Position Interlock | 0 .. 1 | | 0 = Not Ok, 1 = OK |
| 69 | ✓ | | ✓ | ✓ | Sweep Program Is In Edit | 0 .. 1 | | 0 = Not Edit, 1 = Editing |

| System Alarms (GVID 19) | |
|-------------------------|-----------------------------|
| Bit | Alarm Description |
| 0 | Master/Slave Communion Loss |
| ... 15 | Null |

| HVPS/FPS Interlock Alarms (GVID 20) | |
|-------------------------------------|---|
| Bit | Alarm Description |
| 0 | Aux Connect Aux Interlock Alarm |
| 1 | Aux Connect Poptop Not Down Interlock Alarm |
| 2 | Aux Connect Sweep Position Interlock Alarm |
| 3 | Aux Connect Tank Interlock Alarm |
| 4 | Aux Connect Vacuum Interlock Alarm |
| 5 | Aux Connect Water Supply Interlock Alarm |
| ... 15 | Null |

| HVPS/FPS Block 1 Alarms (GVID 30) | |
|-----------------------------------|---|
| Bit | Alarm Description |
| 0 | FPS Gun Ctrl Is On Failure |
| 1 | FPS Gun Ctrl Go On Timeout |
| 2 | FPS Missing Interlock Wire |
| 3 | FPS Module Lost Communication |
| 4 | HVPS Faulted Alarm |
| 5 | HVPS Go On Timeout |
| 6 | HVPS Is On Failure |
| 7 | HVPS Missing Interlock Wire |
| 8 | HVPS Module Lost Internal Communication |
| 9 | HVPS Not Ready Timeout |
| 10 | HVPS Type Configuration Missing |
| 11 | Turret Interlock Position Not Valid |
| 12 | Turret Is Rotating Interlock |
| 13 | Sweep Communication Not OK Interlock |
| 14 | Sweep Interlock Position Limit |
| 15 | Serial Comm Loop Back Not Detected |

| HVPS/FPS Block 2 Alarms (GVID 31) | |
|-----------------------------------|-------------------|
| Bit | Alarm Description |
| ... 31 | Null |

| TRC Alarms (GVID 50) | |
|----------------------|---|
| Bit | Alarm Description |
| 0 | Turret Configuration, Encoder Index Not Found |
| 1 | Turret Failed To Find Position |
| 2 | Turret Missing Interlock Wire |
| 3 | Turret Module Lost Internal Communication |
| 4 | Turret Motor Stalled |
| ...15 | Null |

| Sweep Alarms (GVID 60) | |
|------------------------|--|
| Bit | Alarm Description |
| 0 | Sweep Coil Over Current Fault |
| 1 | Sweep Module Lost Internal Communication |
| ... 15 | Null |

